



Onsite[®]

CATALOGUE 2025



Meridian LJ: Located in Shanghai for all packaging and distribution coordination activities.



Meridian LT: Located in Pinghu, Zhejiang province for the production of all injection molded plastic products.



Hongyang: Located in Shengzhou, Zhejiang province for the production of all injection molded plastic products.



Meridian LM: Located in Jinhua, Zhejiang province for the production of all steel storage items including storage racks and garage storage systems.



Toolux Sanding: Located in Shengzhou, Zhejiang province for the production of hand tools.



Li Wei: Located in Zhangjiagang, Jiangsu province for the production of hand tools.



Suofuer: Located in Ningbo, Zhejiang province for the production of hand tools.



Since 1992, Meridian International, an ISO9001 accredited company, has successfully established itself as one of the leading organizations serving the tool and hardware market, becoming the headquarters for an effective group of manufacturers with the proven capabilities of serving global customers. Such ability can be attributed to the synchronized approach to manufacturing taken by Meridian, following a collaborative process of internal research, product development and graphic design together with proven sourcing, manufacturing, and distribution capabilities.

Currently, we utilize a team containing more than 30 engineers and industrial designers who are involved in the coordination and execution of conceptual design, mechanical design, and the overall project management activities. In addition to our ongoing cooperation with some of the world's leading design houses, we currently have international branches located in Australia, Luxembourg, United Kingdom, Latin America, United States of America to guarantee our products strength across the competitive global markets. This comprehensive process ensures both the originality and superior quality of our products.

Meridian International also utilizes strong sourcing capabilities, currently working in co-operation with 700+ factories across China and in several other Asian countries. Our experienced product managers and sourcing specialists are constantly working with customers on the development and management of their product ranges.



Meridian International Co., Ltd.

www.meridianintl.com

| | | |
|--------------------|-------|-------|
| FASTENING | ----- | 1-12 |
| STRIKING | ----- | 12-16 |
| MEASURING | ----- | 16-17 |
| LAYOUT | ----- | 17-18 |
| CUTTING | ----- | 18-21 |
| MASONRY & PAINTING | ----- | 21-23 |
| FINISHING | ----- | 23-25 |
| PLUMBING | ----- | 25-26 |
| MECHANICS | ----- | 26-31 |
| ELECTRICIAN | ----- | 31-32 |
| MISCELLANEOUS | ----- | 32 |
| TOOL SETS | ----- | 33-35 |
| PTA & PPE | ----- | 36-38 |
| RETAIL DISPLAYS | ----- | 39 |



LONG NOSE PLIERS



| Item No. | Size | EAN 69426292 | Inner | Outer |
|----------|----------------|-----------------|-------|-------|
| 700001 | 160 mm (6 in.) | 3188 2 | 6 | 36 |
| 700003 | 200 mm (8 in.) | 3189 9 | 6 | 24 |

DIAGONAL PLIERS



| Item No. | Size | EAN 69426292 | Inner | Outer |
|----------|----------------|-----------------|-------|-------|
| 700005 | 160 mm (6 in.) | 3190 5 | 6 | 36 |
| 700006 | 200 mm (8 in.) | 3864 5 | 6 | 24 |

HEAVY DUTY DIAGONAL PLIERS



| Item No. | Size | EAN 69426292 | Inner | Outer |
|----------|----------------|-----------------|-------|-------|
| 700007 | 175 mm (7 in.) | 3191 2 | 6 | 36 |

BOX JOINT PLIERS



| Item No. | Size | EAN 69426292 | Inner | Outer |
|----------|-----------------|-----------------|-------|-------|
| 700048 | 250 mm (10 in.) | 6276 3 | 6 | 24 |

MINI LONG NOSE PLIERS



| Item No. | Size | EAN 69426292 | Inner | Outer |
|----------|----------------|-----------------|-------|-------|
| 700061 | 125 mm (5 in.) | 3198 1 | 6 | 36 |

MINI DIAGONAL PLIERS



| Item No. | Size | EAN 69426292 | Inner | Outer |
|----------|--------------------|-----------------|-------|-------|
| 700063 | 110 mm (4-1/2 in.) | 3199 8 | 6 | 36 |



LINESMAN PLIERS



| Item No. | Size | EAN 69426292 | Inner | Outer |
|----------|----------------|-----------------|-------|-------|
| 700008 | 160 mm (6 in.) | 5239 9 | 6 | 36 |
| 700009 | 175 mm (7 in.) | 3192 9 | 6 | 24 |
| 700011 | 200 mm (8 in.) | 3962 8 | 6 | 24 |

BENT NOSE PLIERS



| Item No. | Size | EAN 69426292 | Inner | Outer |
|----------|----------------|-----------------|-------|-------|
| 700016 | 160 mm (6 in.) | 8686 8 | 6 | 36 |

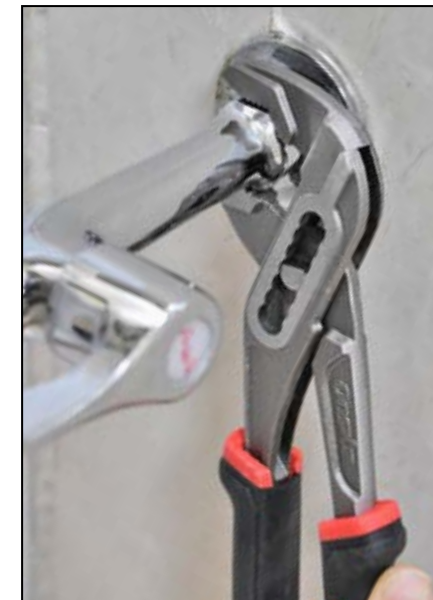

MINI BENT NOSE PLIERS



| Item No. | Size | EAN 69426292 | Inner | Outer |
|----------|----------------|-----------------|-------|-------|
| 700065 | 125 mm (5 in.) | 3200 1 | 6 | 36 |

MINI NEEDLE NOSE PLIERS



| Item No. | Size | EAN 69426292 | Inner | Outer |
|----------|----------------|-----------------|-------|-------|
| 700067 | 150 mm (6 in.) | 3201 8 | 6 | 36 |

WIRE STRIPPER



| Item No. | Size | EAN 69426292 | Inner | Outer |
|----------|----------------|-----------------|-------|-------|
| 700027 | 160 mm (6 in.) | 8656 1 | 6 | 36 |

SLIP JOINT PLIERS



| Item No. | Size | EAN 69426292 | Inner | Outer |
|----------|----------------|-----------------|-------|-------|
| 700031 | 160 mm (6 in.) | 3193 6 | 6 | 36 |
| 700033 | 200 mm (8 in.) | 3194 3 | 6 | 24 |

GROOVE JOINT PLIERS



| Item No. | Size | EAN 69426292 | Inner | Outer |
|----------|-----------------|-----------------|-------|-------|
| 700041 | 200 mm (8 in.) | 3195 0 | 6 | 24 |
| 700043 | 250 mm (10 in.) | 3196 7 | 6 | 24 |
| 700045 | 300 mm (12 in.) | 3197 4 | 6 | 12 |

MINI END NIPPER PLIERS



| Item No. | Size | EAN 69426292 | Inner | Outer |
|----------|--------------------|-----------------|-------|-------|
| 700069 | 110 mm (4-1/2 in.) | 3865 2 | 6 | 36 |

3PC PLIERS SET



- 160 mm (6 in.) long nose pliers
- 160 mm (6 in.) diagonal pliers
- 175 mm (7 in.) linesman pliers

| Item No. | Size | EAN 69426292 | Inner | Outer |
|----------|------|-----------------|-------|-------|
| 700083 | 3pc | 3203 2 | 6 | 12 |

4PC PLIERS & SCREWDRIVER SET



- 160 mm (6 in.) long nose pliers
- 160 mm (6 in.) diagonal pliers
- 160 mm (6 in.) linesman pliers
- 6-in-1 screwdriver

| Item No. | Size | EAN 69426292 | Inner | Outer |
|----------|------|-----------------|-------|-------|
| 700085 | 4pc | 3456 2 | 6 | 12 |

LONG NOSE PLIERS



| Item No. | Size | EAN 69426292 | Inner | Outer |
|----------|----------------|-----------------|-------|-------|
| 700101 | 160 mm (6 in.) | 3208 7 | 6 | 36 |
| 700103 | 200 mm (8 in.) | 3209 4 | 6 | 24 |

DIAGONAL PLIERS



| Item No. | Size | EAN 69426292 | Inner | Outer |
|----------|----------------|-----------------|-------|-------|
| 700105 | 160 mm (6 in.) | 3210 0 | 6 | 36 |
| 700106 | 200 mm (8 in.) | 3866 9 | 6 | 24 |

HEAVY DUTY DIAGONAL PLIERS



| Item No. | Size | EAN 69426292 | Inner | Outer |
|----------|----------------|-----------------|-------|-------|
| 700107 | 175 mm (7 in.) | 3211 7 | 6 | 36 |

MINI BENT NOSE PLIERS



| Item No. | Size | EAN 69426292 | Inner | Outer |
|----------|----------------|-----------------|-------|-------|
| 700165 | 125 mm (5 in.) | 3220 9 | 6 | 36 |

3PC PLIERS SET



- 160 mm (6 in.) long nose pliers,
- 160 mm (6 in.) diagonal pliers,
- 175 mm (7 in.) linesman pliers

| Item No. | Size | EAN 69426292 | Inner | Outer |
|----------|------|-----------------|-------|-------|
| 700181 | 3pc | 8865 7 | 6 | 12 |

3PC PLIERS SET



- 160 mm (6 in.) long nose pliers
- 160 mm (6 in.) diagonal pliers
- 160 mm (6 in.) slip joint pliers

| Item No. | Size | EAN 69426292 | Inner | Outer |
|----------|------|-----------------|-------|-------|
| 700183 | 3pc | 3223 0 | 6 | 12 |

LINESMAN PLIERS



| Item No. | Size | EAN 69426292 | Inner | Outer |
|----------|----------------|-----------------|-------|-------|
| 700108 | 160 mm (6 in.) | 5240 5 | 6 | 24 |
| 700109 | 175 mm (7 in.) | 3212 4 | 6 | 24 |
| 700111 | 200 mm (8 in.) | 3867 6 | 6 | 24 |

SLIP JOINT PLIERS



| Item No. | Size | EAN 69426292 | Inner | Outer |
|----------|----------------|-----------------|-------|-------|
| 700131 | 160 mm (6 in.) | 3213 1 | 6 | 36 |
| 700133 | 200 mm (8 in.) | 3214 8 | 6 | 24 |

GROOVE JOINT PLIERS



| Item No. | Size | EAN 69426292 | Inner | Outer |
|----------|-----------------|-----------------|-------|-------|
| 700141 | 200 mm (8 in.) | 3215 5 | 6 | 24 |
| 700143 | 250 mm (10 in.) | 3216 2 | 6 | 24 |
| 700145 | 300 mm (12 in.) | 3217 9 | 6 | 12 |

MINI NEEDLE NOSE PLIERS



| Item No. | Size | EAN 69426292 | Inner | Outer |
|----------|----------------|-----------------|-------|-------|
| 700167 | 150 mm (6 in.) | 3221 6 | 6 | 36 |

4PC PLIERS & WRENCH SET



- 160 mm (6 in.) long nose pliers
- 200 mm (8 in.) slip joint pliers
- 160 mm (6 in.) diagonal pliers
- 200 mm (8 in.) adjustable wrench

| Item No. | Size | EAN 69426292 | Inner | Outer |
|----------|------|-----------------|-------|-------|
| 700186 | 4pc | 3225 4 | 6 | 12 |

4PC MINI PLIERS SET



- mini long nose pliers
- mini bent nose pliers
- mini diagonal pliers
- mini end nipper pliers

| Item No. | Size | EAN 69426292 | Inner | Outer |
|----------|------|-----------------|-------|-------|
| 700194 | 4pc | 3227 8 | 6 | 12 |

MINI LONG NOSE PLIERS



| Item No. | Size | EAN 69426292 | Inner | Outer |
|----------|----------------|-----------------|-------|-------|
| 700161 | 125 mm (5 in.) | 3218 6 | 6 | 36 |

MINI DIAGONAL PLIERS



| Item No. | Size | EAN 69426292 | Inner | Outer |
|----------|--------------------|-----------------|-------|-------|
| 700163 | 110 mm (4-1/2 in.) | 3219 3 | 6 | 36 |



FENCE PLIERS



| Item No. | Size | EAN 69426292 | Inner | Outer |
|----------|-----------------|-----------------|-------|-------|
| 700210 | 250 mm (10 in.) | 3228 5 | 6 | 24 |

CONSTRUCTION PLIERS



| Item No. | Size | EAN 69426292 | Inner | Outer |
|----------|----------------|-----------------|-------|-------|
| 700306 | 225 mm (9 in.) | 5798 1 | 6 | 24 |



LOCKING PLIERS



| Item No. | Size | EAN | Inner | Outer |
|----------|-----------------|----------|-------|-------|
| 700501 | 125 mm (5 in.) | 69426292 | 6 | 36 |
| 700503 | 175 mm (7 in.) | 3231 5 | 6 | 24 |
| 700505 | 250 mm (10 in.) | 3232 2 | 6 | 24 |

LONG NOSE LOCKING PLIERS



| Item No. | Size | EAN | Inner | Outer |
|----------|--------------------|--------|-------|-------|
| 700507 | 165 mm (6-1/2 in.) | 3872 0 | 6 | 24 |
| 700509 | 235 mm (9-1/2 in.) | 3233 9 | 6 | 24 |

LOCKING PLIERS - STRAIGHT JAW



| Item No. | Size | EAN | Inner | Outer |
|----------|-----------------|--------|-------|-------|
| 700525 | 250 mm (10 in.) | 3873 7 | 6 | 24 |

2PC LOCKING PLIERS SET



- 165 mm (6-1/2 in.) long nose locking pliers
- 250 mm (10 in.) locking pliers

| Item No. | Size | EAN | Inner | Outer |
|----------|------|--------|-------|-------|
| 700512 | 2pc | 3234 6 | 6 | 12 |

3PC MINI LOCKING PLIERS SET



- 110 mm curve jaw
- 120 mm long nose
- 125 mm C-type

| Item No. | Size | EAN | Inner | Outer |
|----------|------|--------|-------|-------|
| 700513 | 3pc | 1873 9 | 6 | 24 |

2PC OFFSET SCREWDRIVER SET



- SL- 5 mm (3/16 in.) & PH-#1
- SL- 6 mm (1/4 in.) & PH-#2

| Item No. | Size | EAN | Inner | Outer |
|----------|------|--------|-------|-------|
| 702432 | 2pc | 3256 8 | 12 | 120 |

BENDING PLIERS 45 DEGREE



NEW ADD

| Item No. | Size | EAN | Inner | Outer |
|----------|-----------------|--------|-------|-------|
| 700912 | 280 mm (11 in.) | 0934 8 | 5 | 20 |

CIRCLIP PLIERS STRAIGHT EXTERIOR



| Item No. | Size | EAN | Inner | Outer |
|----------|----------------|--------|-------|-------|
| 701026 | 175 mm (7 in.) | 0102 1 | 6 | 24 |

CIRCLIP PLIERS STRAIGHT INTERIOR



| Item No. | Size | EAN | Inner | Outer |
|----------|----------------|--------|-------|-------|
| 701027 | 175 mm (7 in.) | 0103 8 | 6 | 24 |

CLASSIC SCREWDRIVER-SLOT

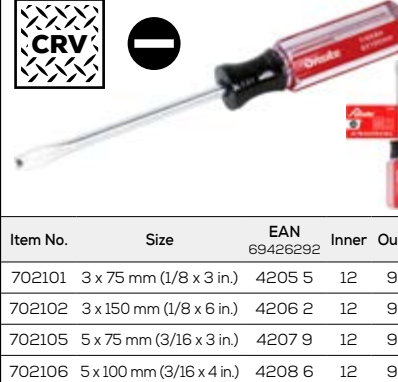

CRV

| Item No. | Size | EAN | Inner | Outer |
|----------|-----------------------------|--------|-------|-------|
| 702101 | 3 x 75 mm (1/8 x 3 in.) | 4205 5 | 12 | 96 |
| 702102 | 3 x 150 mm (1/8 x 6 in.) | 4206 2 | 12 | 96 |
| 702105 | 5 x 75 mm (3/16 x 3 in.) | 4207 9 | 12 | 96 |
| 702106 | 5 x 100 mm (3/16 x 4 in.) | 4208 6 | 12 | 96 |
| 702107 | 5 x 200 mm (3/16 x 8 in.) | 4209 3 | 12 | 96 |
| 702108 | 6 x 38 mm (1/4 x 1-1/2 in.) | 4210 9 | 12 | 96 |
| 702109 | 6 x 100 mm (1/4 x 4 in.) | 3878 2 | 6 | 72 |
| 702111 | 6 x 150 mm (1/4 x 6 in.) | 3879 9 | 6 | 72 |
| 702113 | 6 x 300 mm (1/4 x 12 in.) | 4211 6 | 6 | 72 |

CLASSIC SCREWDRIVER-PHILLIPS

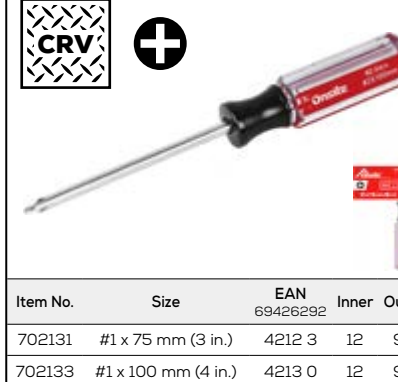

CRV

| Item No. | Size | EAN | Inner | Outer |
|----------|------------------------|--------|-------|-------|
| 702131 | #1 x 75 mm (3 in.) | 4212 3 | 12 | 96 |
| 702133 | #1 x 100 mm (4 in.) | 4213 0 | 12 | 96 |
| 702135 | #2 x 38 mm (1-1/2 in.) | 4214 7 | 12 | 96 |
| 702137 | #2 x 200 mm (8 in.) | 4215 4 | 6 | 72 |
| 702141 | #2 x 100 mm (4 in.) | 3880 5 | 6 | 72 |
| 702143 | #2 x 150 mm (6 in.) | 3881 2 | 6 | 72 |
| 702145 | #2 x 300 mm (12 in.) | 4216 1 | 6 | 72 |

34PC BIT SET



- Bit holder
- Extension bar 60 mm
- 32pc bits: SL- 3, 4, 5, 6, 6.5 mm; PH- #0, #1 x 2, #2 x 3, #3 x 2; PZ- #1 x 2, #2 x 3, #3 x 2; HEX- 2, 3, 4, 5, 5.5, 6 mm; T-10, T-15, T-20, T-25, T-30, T-40

| Item No. | Size | EAN | Inner | Outer |
|----------|------|--------|-------|-------|
| 702711 | 34pc | 0909 6 | 6 | 24 |

4PC SNAP RING PLIERS SET



- 0°, 45°, 90°
- internal and external use

| Item No. | Size | EAN | Inner | Outer |
|----------|----------------|--------|-------|-------|
| 701024 | 150 mm (6 in.) | 3874 4 | 6 | 24 |

CIRCLIP PLIERS BENT EXTERIOR



NEW ADD

| Item No. | Size | EAN | Inner | Outer |
|----------|----------------|--------|-------|-------|
| 701028 | 175 mm (7 in.) | 5858 2 | 6 | 24 |

CIRCLIP PLIERS BENT INTERIOR



NEW ADD

| Item No. | Size | EAN | Inner | Outer |
|----------|----------------|--------|-------|-------|
| 701029 | 175 mm (7 in.) | 5859 9 | 6 | 24 |

6-IN-1 SCREWDRIVER



- SL- 5 mm (3/16 in.), 6 mm (1/4 in.); PH- #1, #2
- SOCKET- 1/4 in., 5/16 in.

| Item No. | Size | EAN | Inner | Outer |
|----------|--------|--------|-------|-------|
| 702407 | 6 in 1 | 3961 1 | 12 | 96 |

8-IN-1 SCREWDRIVER



- SL- 5 mm (3/16 in.), 6 mm (1/4 in.); PH- #1, #2, #3; T-15, T-20
- Pick up tool 600 mm (24 in.)

| Item No. | Size | EAN | Inner | Outer |
|----------|--------|--------|-------|-------|
| 702428 | 8 in 1 | 0905 8 | 6 | 36 |

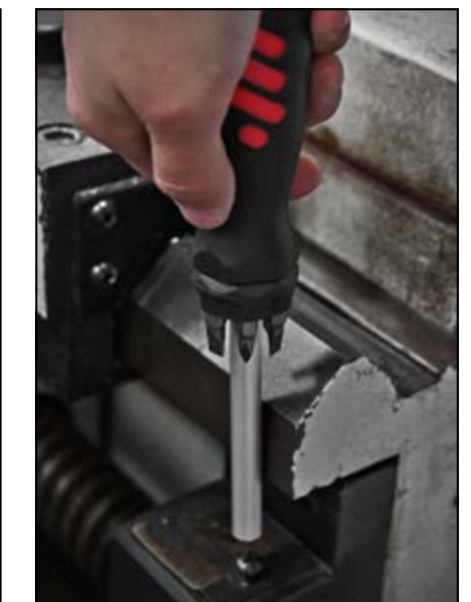



8PC PRECISION SCREWDRIVER SET

- SL- 1.5 mm (1/16 in.), 2 mm (5/64 in.), 2.5 mm (3/32 in.)
- PH- #000, #00, #0, T-6, T-7

| Item No. | Size | EAN | Inner | Outer |
|----------|------|--------|-------|-------|
| 702509 | 8pc | 0906 5 | 6 | 24 |

6PC PRECISION SCREWDRIVER SET

- SL-1.4 mm (3/64 in.), 1.8 mm (5/64 in.), 2.4 mm (3/32 in.), 3.0 mm (1/8 in.)
- PH- #0, #1

| Item No. | Size | EAN | Inner | Outer |
|----------|------|--------|-------|-------|
| 702513 | 6pc | 3265 0 | 12 | 48 |

2-IN-1 SCREWDRIVER

- interchangeable shank: SL- 6.5 mm (1/4 in.) & PH- #2 x 100 mm (4 in.)

| Item No. | Size | EAN | Inner | Outer |
|----------|--------|--------|-------|-------|
| 702415 | 2 in 1 | 4198 0 | 12 | 48 |

6-IN-1 SCREWDRIVER

- SL- 5 mm (3/16 in.), 6 mm (1/4 in.); PH- #1, #2
- SOCKET-1/4 in., 5/16 in.

| Item No. | Size | EAN | Inner | Outer |
|----------|--------|--------|-------|-------|
| 702416 | 6 in 1 | 5550 5 | 12 | 48 |

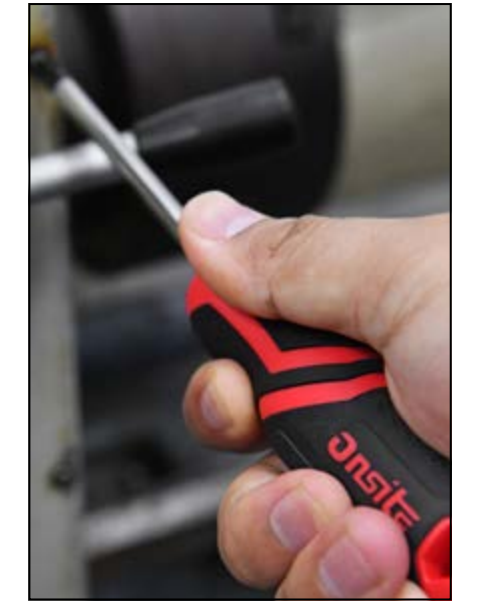

SCREWDRIVER - SLOT

| Item No. | Size | EAN | Inner | Outer |
|----------|------------------------|--------|-------|-------|
| 702201 | 3x60mm(1/8x2-1/2in.) | 5521 5 | 6 | 72 |
| 702203 | 3x75mm(1/8x3in.) | 5522 2 | 6 | 72 |
| 702204 | 5.5x75mm(3/16x3in.) | 5523 9 | 6 | 72 |
| 702205 | 5.5x100mm(3/16x4in.) | 5524 6 | 6 | 72 |
| 702207 | 6.5x38mm(1/4x1-1/2in.) | 5525 3 | 6 | 72 |
| 702209 | 6.5x100mm(1/4x4in.) | 5526 0 | 6 | 72 |
| 702211 | 6.5x150mm(1/4x6in.) | 5527 7 | 6 | 60 |
| 702213 | 8x150mm(5/16x6in.) | 5528 4 | 6 | 60 |

SCREWDRIVER - PHILLIPS

| Item No. | Size | EAN | Inner | Outer |
|----------|------------------------|--------|-------|-------|
| 702231 | #0 x 60 mm (2-1/2 in.) | 5529 1 | 6 | 72 |
| 702233 | #0 x 75 mm (3 in.) | 5530 7 | 6 | 72 |
| 702235 | #1 x 75 mm (3 in.) | 5531 4 | 6 | 72 |
| 702237 | #1 x 100 mm (4 in.) | 5532 1 | 6 | 72 |
| 702239 | #2 x 38 mm (1-1/2 in.) | 5533 8 | 6 | 72 |
| 702241 | #2 x 100 mm (4 in.) | 5534 5 | 6 | 72 |
| 702243 | #2 x 150 mm (6 in.) | 5535 2 | 6 | 60 |
| 702245 | #3 x 150 mm (6 in.) | 5536 9 | 6 | 60 |

2PC STUBBY SCREWDRIVER SET

| Item No. | Size | EAN | Inner | Outer |
|----------|---|--------|-------|-------|
| 702313 | SL 6.5 x 38 mm (1/4 x 1-1/2 in.) PH #2 x 38 mm (1-1/2 in.) | 8868 8 | 6 | 48 |

6PC SCREWDRIVER SET

- SL- 3 x 75 mm, 5.5 x 100 mm, 6.5 x 100 mm
- PH- #0 x 75 mm, #1 x 75 mm, #2 x 100 mm

| Item No. | Size | EAN | Inner | Outer |
|----------|------|--------|-------|-------|
| 702476 | 6pc | 8881 7 | 6 | 24 |

6PC SCREWDRIVER SET

- SL- 6.5 x 38 mm (1/4 x 1-1/2 in.), 5.5 x 100 mm (3/16 x 4 in.), 6.5 x 100 mm (1/4 x 4 in.)
- PH- #2 x 38 mm (1-1/2 in.), #1 x 100 mm (4 in.), #2 x 100 mm (4 in.)

| Item No. | Size | EAN | Inner | Outer |
|----------|------|--------|-------|-------|
| 702478 | 6pc | 5552 9 | 6 | 24 |

6PC TORX® SCREWDRIVER SET

- T-10, T-15, T-20, T-25, T-27, T-30 x 100 mm (4 in.)
- TORX® is a Trademark of Textron Fastening Systems

| Item No. | Size | EAN | Inner | Outer |
|----------|------|--------|-------|-------|
| 702479 | 6pc | 5553 6 | 6 | 24 |

SCREWDRIVER - POZI

| Item No. | Size | EAN | Inner | Outer |
|----------|------------------------|--------|-------|-------|
| 702261 | #0 x 60 mm (2-1/2 in.) | 5537 6 | 6 | 72 |
| 702263 | #1 x 75 mm (3 in.) | 5538 3 | 6 | 72 |
| 702265 | #2 x 38 mm (1-1/2 in.) | 5539 0 | 6 | 72 |
| 702267 | #2 x 100 mm (4 in.) | 5540 6 | 6 | 72 |
| 702269 | #3 x 150 mm (6 in.) | 5541 3 | 6 | 60 |

SCREWDRIVER - TORX®

TORX® is a Trademark of Textron Fastening Systems

| Item No. | Size | EAN | Inner | Outer |
|----------|-----------------------|--------|-------|-------|
| 702270 | T-8 x 100 mm (4 in.) | 9690 4 | 6 | 72 |
| 702271 | T-10 x 100 mm (4 in.) | 5542 0 | 6 | 72 |
| 702273 | T-15 x 100 mm (4 in.) | 5543 7 | 6 | 72 |
| 702275 | T-20 x 100 mm (4 in.) | 5544 4 | 6 | 72 |
| 702277 | T-25 x 100 mm (4 in.) | 5545 1 | 6 | 72 |
| 702279 | T-27 x 100 mm (4 in.) | 5546 8 | 6 | 72 |
| 702281 | T-30 x 100 mm (4 in.) | 5547 5 | 6 | 72 |
| 702283 | T-40 x 100 mm (4 in.) | 9796 3 | 6 | 60 |
| 702284 | T-45 x 100 mm (4 in.) | 5368 6 | 6 | 60 |

2PC SCREWDRIVER SET

| Item No. | Size | EAN | Inner | Outer |
|----------|---|--------|-------|-------|
| 702312 | SL 3 x 75 mm (1/8 x 3 in.) PH #0 x 75 mm (3 in.) | 5548 2 | 6 | 48 |
| 702314 | SL 6.5 x 100 mm (1/4 x 4 in.) PH #2 x 100 mm (4 in.) | 5549 9 | 6 | 48 |

29PC SCREWDRIVER & SOCKET SET

- ratchet screwdriver
- 16pc bits: SL- 3, 4, 5, 6, 7 mm; PH- #1, #2, #3; PZ- #1, #2, #3; T-10, T-15, T-20, T-25; ADP.
- 12pc 1/4 in. Dr. sockets: 5, 6, 7, 8, 9, 10 mm; 1/4, 5/16, 11/32, 3/8, 7/16, 1/2 in.

| Item No. | Size | EAN | Inner | Outer |
|----------|------|--------|-------|-------|
| 702461 | 29pc | 3894 2 | 6 | 24 |

26PC RATCHET DRIVER SET

- nylon bag
- ratchet handle
- 6pc nut driver 5, 6, 7, 8, 9, 10 mm
- 18pc 50 mm bits: SL- 3, 4, 5, 6, 7 mm; PH- #0, #1, #2, #3; PZ- #1, #2, #3; T-10, T-15, T-20, T-25, T-27, T-30

| Item No. | Size | EAN | Inner | Outer |
|----------|------|--------|-------|-------|
| 702484 | 26pc | 8654 7 | 6 | 24 |

29PC SCREWDRIVER BMC SET

- 1pc magnetic driver
- 20 pc CRV bits
- 8pc screwdriver SL- 6.5 x 38, 4 x 100, 5.5 x 100, 6.5 x 125 mm, PH- #2 x 38, #0 x 75, #1 x 100, #2 x 125 mm

| Item No. | Size | EAN | Inner | Outer |
|----------|-------|--------|-------|-------|
| 702490 | 29 pc | 4021 1 | 0 | 6 |

18PC SCREWDRIVER SET



• 8pc screwdriver: SL- 5.5 x 75 mm, 6.5 x 100 mm, 8 x 150 mm, 6.5 x 38 mm; PH- 1 x 75 mm, #2 x 100 mm, #3 x 150 mm, #2 x 38 mm

• 10pc precision screwdriver: SL- 2.5, 3.0 mm; PH- #00, #0; T-5, T-6, T-7, T-8, T-9, T-10

| Item No. | Size | EAN | Inner | Outer |
|----------|------|--------|-------|-------|
| 702483 | 18pc | 0135 9 | 0 | 6 |

8PC HEX KEY SET



• 702618: 1.5, 2, 2.5, 3, 4, 5, 5.5, 6 mm
• 702620: 1/16, 5/64, 3/32, 1/8, 5/32, 3/16, 7/32, 1/4 in.

| Item No. | Size | EAN | Inner | Outer |
|----------|--------|--------|-------|-------|
| 702618 | METRIC | 0907 2 | 12 | 96 |
| 702620 | SAE | 3266 7 | 12 | 96 |

8PC FOLDING HEX KEY SET



• 702631: 1.5, 2, 2.5, 3, 4, 5, 6, 8 mm
• 702633: 1/16, 5/64, 3/32, 1/8, 5/32, 3/16, 1/4, 5/16 in.

| Item No. | Size | EAN | Inner | Outer |
|----------|--------|--------|-------|-------|
| 702631 | METRIC | 3882 9 | 6 | 36 |
| 702633 | SAE | 3883 6 | 6 | 36 |

8PC FOLDING TORX® KEY SET



TORX® is a Trademark of Textron Fastening Systems

| Item No. | Size | EAN | Inner | Outer |
|----------|---|--------|-------|-------|
| 702635 | T-9, T-10, T-15, T-20, T-25, T-27, T-30, T-40 | 3884 3 | 6 | 36 |

8PC FOLDING TORX® TAMPER KEY SET



TORX® is a Trademark of Textron Fastening Systems

| Item No. | Size | EAN | Inner | Outer |
|----------|---|--------|-------|-------|
| 702636 | T-9, T-10, T-15, T-20, T-25, T-27, T-30, T-40 | 8666 0 | 6 | 36 |

70PC SCREWDRIVER SET



• 1pc rack
• 1pc bit holder
• 18pc screwdrivers: SL- 3 x 75 mm, 5.5 x 100 mm, 6.5 x 125 mm, 6.5 x 38 mm, 8 x 150 mm; PH- #0 x 75 mm, #1 x 100 mm, #2 x 125 mm, #2 x 38 mm; PZ- #0 x 75 mm, #1 x 75 mm, #2 x 100 mm; T10 x 75 mm, T15 x 100 mm, T20 x 100 mm; S0 x 75 mm, S1 x 75 mm, S2 x 100 mm

• 8pc precision screwdrivers: SL- 2.5, 3.0 mm; PH- #00, #0; T-6, T-7, T-8, T-10
• 6pc nut drivers: 5, 6, 7, 8, 9, 10 mm
• 20 pc bits: SL- 3, 4, 5, 6 mm; PH- #0, #1, #2, #3; PZ- #0, #1, #2, #3; S0, S1, S2, S3; T-10, T-15, T-20, T-25
• 16pc hex key: 1/16, 5/64, 3/32, 1/8, 5/32, 3/16, 7/32, 1/4 in.; 1.5, 2, 2.5, 3, 4, 5, 5.5, 6 mm

| Item No. | Size | EAN | Inner | Outer |
|----------|------|--------|-------|-------|
| 702489 | 70pc | 1871 5 | 0 | 4 |

25PC HEX KEY SET



• SAE- 1/16, 5/64, 3/32, 7/64, 1/8, 9/64, 5/32, 3/16, 7/32, 1/4, 5/16, 3/8 in.
• Metric- 1.27, 1.5, 2, 2.5, 3, 4, 4.5, 5, 5.5, 6, 7, 8, 10 mm

| Item No. | Size | EAN | Inner | Outer |
|----------|------|--------|-------|-------|
| 702625 | 25pc | 3267 4 | 6 | 12 |

9PC LONG HEX KEY SET



• 702681: 1.5, 2, 2.5, 3, 4, 5, 6, 8, 10 mm
• 702682: 1/16, 5/64, 3/32, 1/8, 5/32, 3/16, 1/4, 5/16, 3/8 in.

| Item No. | Size | EAN | Inner | Outer |
|----------|--------|--------|-------|-------|
| 702681 | METRIC | 5373 0 | 6 | 24 |
| 702682 | SAE | 5860 5 | 6 | 24 |

9PC LONG TORX KEY SET



TORX® is a Trademark of Textron Fastening Systems

| Item No. | Size | EAN | Inner | Outer |
|----------|--|--------|-------|-------|
| 702683 | T-10, T-15, T-20, T-25, T-27, T-30, T-40, T-45, T-50 | 4147 8 | 6 | 24 |

20PC NUT DRIVER SET



• Metric: 4, 5, 5.5, 6, 7, 8, 9, 10, 11, 12 mm
• SAE: 1/2, 5/16, 7/16, 3/8, 11/32, 9/32, 1/4, 7/32, 3/16, 5/32 in.

| Item No. | Size | EAN | Inner | Outer |
|----------|------|--------|-------|-------|
| 702752 | 20pc | 4017 4 | 6 | 24 |

100PC SCREWDRIVER SET



• 23pc screwdriver: SL- 3 x 75 mm, 4 x 75 mm, 5.5 x 100 mm, 5.5 x 150 mm, 6.5 x 150 mm, 8 x 150 mm; PH- #0 x 50 mm, #0 x 75 mm, #1 x 100 mm, #1 x 150 mm, #2 x 150 mm; PZ- #0 x 75 mm, #1 x 100 mm, #2 x 100 mm; T-9 x 75 mm, T-10 x 100 mm, T-15 x 100 mm, T-20 x 100 mm, T-25 x 100 mm, T-25 x 100 mm, T-27 x 100 mm, T-30 x 100 mm, T-30 x 100 mm

• 8pc 50 mm precision screwdriver: SL- 2.5 mm, 3.0 mm; PH- #00, #0, T-5, T-6, T-7, T-8
• 1pc ratchet handle

• 2pc offset screwdriver: SL- 5 mm & PH- #1, SL- 6 mm & PH- #2
• 6pc nut driver: 5, 6, 7, 8, 9, 10 mm
• 60pc 25 mm bits: SL- 3 mm(2), 4 mm(2), 5 mm(2), 6 mm(5), 7 mm; PH- #0(2), #1(3), #2(6), #3; PZ- #0(2), #1(2), #2(4), #3; S0, S1, S2(2), S3; T-10(2), T-15(2), T-20(2), T-25(2), T-27, T-30, T-35, T-40; HEX- 1/8(2), 5/32, 3/16, 1/4 in.(2), 3, 4, 5, 6 mm

| Item No. | Size | EAN | Inner | Outer |
|----------|-------|--------|-------|-------|
| 702488 | 100pc | 8681 3 | 0 | 4 |

18PC BALL END HEX KEY SET



• SAE- 1/16, 5/64, 3/32, 1/8, 5/32, 3/16, 1/4, 5/16, 3/8 in.
• Metric- 1.5, 2, 2.5, 3, 4, 5, 6, 8, 10 mm

| Item No. | Size | EAN | Inner | Outer |
|----------|------|--------|-------|-------|
| 702628 | 18pc | 3268 1 | 6 | 12 |

9PC SHORT HEX KEY SET



• 702684: 1.5, 2, 2.5, 3, 4, 5, 6, 8, 10 mm
• 702685: 1/16, 5/64, 3/32, 1/8, 5/32, 3/16, 1/4, 5/16, 3/8 in.

| Item No. | Size | EAN | Inner | Outer |
|----------|--------|--------|-------|-------|
| 702684 | METRIC | 6245 9 | 6 | 24 |
| 702685 | SAE | 9797 0 | 6 | 24 |

9PC SHORT TORX KEY SET

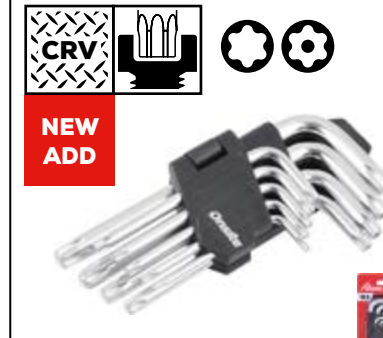

TORX® is a Trademark of Textron Fastening Systems

| Item No. | Size | EAN | Inner | Outer |
|----------|--|--------|-------|-------|
| 702686 | T-10, T-15, T-20, T-25, T-27, T-30, T-40, T-45, T-50 | 0191 5 | 6 | 24 |

14PC MAGNETIC NUT DRIVER SET

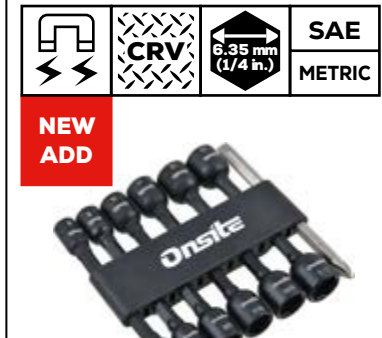

• 12 pc 48 mm magnetic nut driver, 1/4, 5/16, 5/16, 3/8, 7/16, 1/2 in.; 6, 8, 10, 11, 12, 13 mm
• 2 pc 50 mm bits Slot 1/4 in. (6 mm) & PH #2

| Item No. | Size | EAN | Inner | Outer |
|----------|-------|--------|-------|-------|
| 702774 | 14 pc | 4018 1 | 6 | 24 |

ADJUSTABLE WRENCH



| Item No. | Size | EAN 69426292 | Inner | Outer |
|----------|-----------------|-----------------|-------|-------|
| 704001 | 100 mm (4 in.) | 3269 8 | 6 | 36 |
| 704011 | 375 mm (15 in.) | 3274 2 | 6 | 12 |
| 704013 | 450 mm (18 in.) | 3275 9 | 0 | 6 |
| 704015 | 600 mm (24 in.) | 3276 6 | 0 | 4 |

ADJUSTABLE WRENCH



| Item No. | Size | EAN 69426292 | Inner | Outer |
|----------|-----------------|-----------------|-------|-------|
| 704003 | 150 mm (6 in.) | 3270 4 | 6 | 36 |
| 704005 | 200 mm (8 in.) | 3271 1 | 6 | 36 |
| 704007 | 250 mm (10 in.) | 3272 8 | 6 | 36 |
| 704009 | 300 mm (12 in.) | 3273 5 | 6 | 24 |

3PC ADJUSTABLE WRENCH SET



• 150 mm (6 in.), 200 mm (8 in.), 250 mm

| Item No. | Size | EAN 69426292 | Inner | Outer |
|----------|------|-----------------|-------|-------|
| 704023 | 3pc | 3277 3 | 6 | 12 |

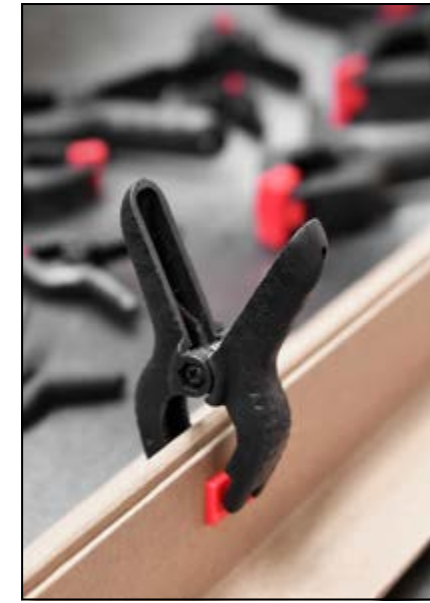

14PC NYLON CLAMP SET



• 4 x 50 mm, 4 x 75 mm, 2 x 100 mm, 2 x 150 mm, 2 x 225 mm

| Item No. | Size | EAN 69426292 | Inner | Outer |
|----------|------|-----------------|-------|-------|
| 705184 | 14pc | 8678 3 | 0 | 12 |

SPRING CLAMP



| Item No. | Size | EAN 69426292 | Inner | Outer |
|----------|----------------|-----------------|-------|-------|
| 705204 | 100 mm (4 in.) | 3286 5 | 6 | 60 |
| 705206 | 150 mm (6 in.) | 3287 2 | 6 | 36 |



ADJUSTABLE WRENCH



| Item No. | Size | EAN 69426292 | Inner | Outer |
|----------|-----------------|-----------------|-------|-------|
| 704031 | 150 mm (6 in.) | 0116 8 | 6 | 36 |
| 704032 | 200 mm (8 in.) | 0117 5 | 6 | 36 |
| 704033 | 250 mm (10 in.) | 0119 9 | 6 | 36 |
| 704034 | 300 mm (12 in.) | 0120 5 | 6 | 24 |

2PC F-CLAMP



| Item No. | Size | EAN 69426292 | Inner | Outer |
|----------|-------------|-----------------|-------|-------|
| 705024 | 150 x 50 mm | 8667 7 | 6 | 12 |
| 705032 | 250 x 80 mm | 8668 4 | 0 | 6 |
| 705036 | 400 x 80 mm | 8669 1 | 0 | 6 |

MINI VISE



360°
MAX 50 mm

| Item No. | Size | EAN 69426292 | Inner | Outer |
|----------|---------------|-----------------|-------|-------|
| 705325 | 50 mm (2 in.) | 4133 1 | 0 | 24 |

RIVET GUN WITH 60PC RIVETS



ALUMINIUM
60X

• 2.4 mm (3/32 in.), 3.2 mm (1/8 in.), 4 mm (5/32 in.), 4.8 mm (3/16 in.)

| Item No. | Size | EAN 69426292 | Inner | Outer |
|----------|------|-----------------|-------|-------|
| 705601 | | 3942 0 | 6 | 24 |

FLEX HEAD HEAVY DUTY RIVETGUN



360° ALUMINIUM
NEW ADD

• 2.4 mm (3/32 in.), 3.2 mm (1/8 in.), 4 mm (5/32 in.), 4.8 mm (3/16 in.)

| Item No. | Size | EAN 69426292 | Inner | Outer |
|----------|------|-----------------|-------|-------|
| 705603 | | 9915 8 | 6 | 24 |

C-CLAMP



| Item No. | Size | EAN 69426292 | Inner | Outer |
|----------|----------------|-----------------|-------|-------|
| 705001 | 25 mm (1 in.) | 3278 0 | 6 | 72 |
| 705002 | 50 mm (2 in.) | 3279 7 | 6 | 60 |
| 705003 | 75 mm (3 in.) | 3280 3 | 6 | 24 |
| 705004 | 100 mm (4 in.) | 3281 0 | 6 | 12 |
| 705005 | 125 mm (5 in.) | 3282 7 | 6 | 12 |
| 705006 | 150 mm (6 in.) | 3283 4 | 4 | 8 |
| 705008 | 200 mm (8 in.) | 3284 1 | 4 | 8 |

3PC C-CLAMP SET



• 25 mm (1 in.), 50 mm (2 in.), 75 mm (3 in.)

| Item No. | Size | EAN 69426292 | Inner | Outer |
|----------|------|-----------------|-------|-------|
| 705013 | 3pc | 3285 8 | 6 | 36 |

TRIGGER CLAMP DUAL FUNCTION



500 mm

• one-hand clamping and spreading function
• quick change button

| Item No. | Size | EAN 69426292 | Inner | Outer |
|----------|-----------------|-----------------|-------|-------|
| 705162 | 300 mm (12 in.) | 1445 8 | 6 | 12 |

TABLE VISE



360° MAX 60 mm

| Item No. | Size | EAN 69426292 | Inner | Outer |
|----------|-------------------|-----------------|-------|-------|
| 705330 | 60 mm (2-1/2 in.) | 1798 5 | 0 | 10 |

MACHINIST HAMMER



• wood handle

| Item No. | Size | EAN 69426292 | Inner | Outer |
|----------|-------|-----------------|-------|-------|
| 706001 | 100 g | 6011 0 | 6 | 36 |
| 706002 | 200 g | 6012 7 | 6 | 36 |
| 706003 | 300 g | 6013 4 | 6 | 24 |
| 706004 | 400 g | 6014 1 | 6 | 24 |
| 706005 | 500 g | 6015 8 | 6 | 12 |

MACHINIST HAMMER



NEW ADD
• fiberglass handle

| Item No. | Size | EAN 69426292 | Inner | Outer |
|----------|--------|-----------------|-------|-------|
| 706012 | 200 g | 9917 2 | 6 | 36 |
| 706013 | 300 g | 9923 3 | 6 | 24 |
| 706014 | 400 g | 3812 6 | 6 | 24 |
| 706015 | 500 g | 3814 0 | 6 | 12 |
| 706016 | 600 g | 3815 7 | 6 | 12 |
| 706018 | 800 g | 4081 5 | 6 | 12 |
| 706020 | 1000 g | 4082 2 | 4 | 8 |

STONE HAMMER



• wood handle

| Item No. | Size | EAN 69426292 | Inner | Outer |
|----------|--------|-----------------|-------|-------|
| 706103 | 1250 g | 8650 9 | 6 | 12 |

STONE HAMMER



• fiberglass handle

| Item No. | Size | EAN 69426292 | Inner | Outer |
|----------|--------|-----------------|-------|-------|
| 706112 | 1000 g | 4083 9 | 6 | 12 |
| 706113 | 1250 g | 4850 7 | 6 | 12 |
| 706114 | 1500 g | 4084 6 | 4 | 8 |



DRILLING HAMMER



• wood handle

| Item No. | Size | EAN 69426292 | Inner | Outer |
|----------|----------------|-----------------|-------|-------|
| 706203 | 3 lb (1.36 kg) | 3288 9 | 4 | 8 |

CROSS PEIN HAMMER



• fiberglass handle

| Item No. | Size | EAN 69426292 | Inner | Outer |
|----------|----------------|-----------------|-------|-------|
| 706243 | 3 lb (1.36 kg) | 3290 2 | 4 | 8 |

CROSS PEIN HAMMER



• wood handle

| Item No. | Size | EAN 69426292 | Inner | Outer |
|----------|----------------|-----------------|-------|-------|
| 706253 | 3 lb (1.36 kg) | 3291 9 | 4 | 8 |

STONE HAMMER



830 mm

• fiberglass handle

| Item No. | Size | EAN 69426292 | Inner | Outer |
|----------|------|-----------------|-------|-------|
| 706117 | 4 kg | 4851 4 | 0 | 2 |
| 706118 | 5 kg | 4852 1 | 0 | 2 |

BALL PEIN HAMMER



• fiberglass handle

| Item No. | Size | EAN 69426292 | Inner | Outer |
|----------|----------------|-----------------|-------|-------|
| 706161 | 225 g (8 oz) | 4085 3 | 6 | 24 |
| 706162 | 340 g (12 oz) | 4086 0 | 6 | 24 |
| 706163 | 450 g (16 oz) | 0197 7 | 6 | 12 |
| 706164 | 680 g (24 oz) | 0198 4 | 6 | 12 |
| 706165 | 910 g (32 oz) | 0201 1 | 6 | 12 |
| 706166 | 1200 g (40 oz) | 4087 7 | 4 | 8 |

CLAW HAMMER



• wood handle

| Item No. | Size | EAN 69426292 | Inner | Outer |
|----------|---------------|-----------------|-------|-------|
| 706303 | 225 g (8 oz) | 0910 2 | 6 | 24 |
| 706304 | 340 g (12 oz) | 1883 8 | 6 | 24 |
| 706305 | 450 g (16 oz) | 0911 9 | 6 | 12 |
| 706302 | 570 g (20 oz) | 0794 8 | 6 | 12 |

CLAW HAMMER



• tubular handle

| Item No. | Size | EAN 69426292 | Inner | Outer |
|----------|---------------|-----------------|-------|-------|
| 706313 | 225 g (8 oz) | 3294 0 | 6 | 24 |
| 706315 | 450 g (16 oz) | 1394 9 | 6 | 12 |

CLAW HAMMER



• fiberglass handle

| Item No. | Size | EAN 69426292 | Inner | Outer |
|----------|---------------|-----------------|-------|-------|
| 706323 | 225 g (8 oz) | 1395 6 | 6 | 24 |
| 706324 | 340 g (12 oz) | 0249 3 | 6 | 24 |
| 706325 | 450 g (16 oz) | 0912 6 | 6 | 12 |
| 706327 | 570 g (20 oz) | 4098 3 | 6 | 12 |

SLEDGE HAMMER



• fiberglass handle

| Item No. | Size | EAN 69426292 | Inner | Outer |
|----------|----------------|-----------------|-------|-------|
| 706223 | 3 lb (1.36 kg) | 3289 6 | 4 | 8 |

SLEDGE HAMMER



830 mm

• fiberglass handle

| Item No. | Size | EAN 69426292 | Inner | Outer |
|----------|----------------|-----------------|-------|-------|
| 706225 | 6 lb (2.7 kg) | 4088 4 | 0 | 4 |
| 706226 | 8 lb (3.6 kg) | 4089 1 | 0 | 2 |
| 706227 | 10 lb (4.5 kg) | 4853 8 | 0 | 2 |
| 706228 | 12 lb (5.4 kg) | 4854 5 | 0 | 2 |

AXE



• fiberglass handle

| Item No. | Size | EAN 69426292 | Inner | Outer |
|----------|-------|-----------------|-------|-------|
| 706508 | 600 g | 0913 3 | 6 | 12 |

RUBBER Mallet



• wood handle

| Item No. | Size | EAN 69426292 | Inner | Outer |
|----------|---------------|-----------------|-------|-------|
| 706792 | 340 g (12 oz) | 8379 9 | 6 | 24 |



RUBBER Mallet



• wood handle

| Item No. | Size | EAN 69426292 | Inner | Outer |
|----------|---------------|-----------------|-------|-------|
| 706803 | 450 g (16 oz) | 0914 0 | 6 | 24 |

RUBBER Mallet



• wood handle

| Item No. | Size | EAN 69426292 | Inner | Outer |
|----------|---------------|-----------------|-------|-------|
| 706811 | 225 g (8 oz) | 3296 4 | 6 | 24 |
| 706813 | 450 g (16 oz) | 3297 1 | 6 | 24 |
| 706815 | 900 g (32 oz) | 3298 8 | 6 | 12 |

DEAD BLOW HAMMER

NEW ADD



• fiberglass handle

| Item No. | Size | EAN 69426292 | Inner | Outer |
|----------|---------------|-----------------|-------|-------|
| 706937 | 1360 g (3 lb) | 4090 7 | 6 | 12 |

PRY BAR



| Item No. | Size | EAN 69426292 | Inner | Outer |
|----------|-----------------|-----------------|-------|-------|
| 708013 | 380 mm (15 in.) | 3885 0 | 6 | 36 |

WRECKING BAR



| Item No. | Size | EAN 69426292 | Inner | Outer |
|----------|-----------------|-----------------|-------|-------|
| 708031 | 300 mm (12 in.) | 1615 5 | 10 | 60 |

TAPE MEASURE SOFT GRIP



| Item No. | Size | EAN 69426292 | Inner | Outer |
|----------|----------------------|-----------------|-------|-------|
| 709014 | 3 m (10 ft.) x 16 mm | 3352 7 | 6 | 36 |
| 709015 | 5 m (16 ft.) x 19 mm | 3353 4 | 6 | 36 |

RUBBER Mallet



• fiberglass handle

| Item No. | Size | EAN 69426292 | Inner | Outer |
|----------|---------------|-----------------|-------|-------|
| 706821 | 225 g (8 oz) | 6421 7 | 6 | 24 |
| 706823 | 450 g (16 oz) | 6422 4 | 6 | 24 |
| 706825 | 900 g (32 oz) | 6423 1 | 6 | 12 |



3PC PUNCH & CHISEL SET

CRV



• 3 mm (1/8 in.)
• 3 mm (1/8 in.)
• 10 mm (3/8 in.)

| Item No. | Size | EAN 69426292 | Inner | Outer |
|----------|------|-----------------|-------|-------|
| 708001 | 3pc | 3886 7 | 6 | 36 |

TAPE MEASURE - METRIC



• MID

| Item No. | Size | EAN 69426292 | Inner | Outer |
|----------|-----------------|-----------------|-------|-------|
| 709003 | 3 m x 16 mm MID | 3300 8 | 6 | 36 |
| 709005 | 5 m x 19 mm MID | 3301 5 | 6 | 36 |
| 709007 | 8 m x 25 mm MID | 3302 2 | 6 | 24 |

TAPE MEASURE - METRIC & SAE



| Item No. | Size | EAN 69426292 | Inner | Outer |
|----------|--------------------------------|-----------------|-------|-------|
| 709203 | 3.5 m x 16 mm (5/8 in.) | 3309 1 | 6 | 36 |
| 709205 | 5 m (16 ft.) x 19 mm (3/4 in.) | 0920 1 | 6 | 36 |
| 709207 | 8 m (26 ft.) x 25 mm (1 in.) | 0921 8 | 6 | 24 |

TAPE MEASURE ABS



| Item No. | Size | EAN 69426292 | Inner | Outer |
|----------|------------------------|-----------------|-------|-------|
| 709031 | 3 m (10 ft.) x 16 mm | 3354 1 | 6 | 36 |
| 709032 | 5 m (16 ft.) x 19 mm | 3355 8 | 6 | 36 |
| 709033 | 7.5 m (25 ft.) x 25 mm | 1787 9 | 6 | 24 |

3PC WOOD CHISEL SET

CRV



• 13 mm (1/2 in.)
• 19 mm (3/4 in.)
• 25 mm (1 in.)
• metal end cap

| Item No. | Size | EAN 69426292 | Inner | Outer |
|----------|------|-----------------|-------|-------|
| 707003 | 3pc | 0917 1 | 6 | 12 |

3PC WOOD CHISEL SET

CRV



• 13 mm (1/2 in.)
• 19 mm (3/4 in.)
• 25 mm (1 in.)
• metal end cap

| Item No. | Size | EAN 69426292 | Inner | Outer |
|----------|------|-----------------|-------|-------|
| 707006 | 3pc | 0444 2 | 6 | 12 |

3PC NAIL PUNCH SET



• 1.6 mm (1/16 in.)
• 2.4 mm (3/32 in.)
• 3.2 mm (1/8 in.)

| Item No. | Size | EAN 69426292 | Inner | Outer |
|----------|------|-----------------|-------|-------|
| 708003 | 3pc | 3299 5 | 6 | 36 |

PLASTIC VERNIER CALIPER



• Metric & SAE
• Plastic

| Item No. | Size | EAN 69426292 | Inner | Outer |
|----------|----------------|-----------------|-------|-------|
| 709380 | 150 mm (6 in.) | 1799 2 | 0 | 30 |

VERNIER CALIPER



• Metric & SAE

| Item No. | Size | EAN 69426292 | Inner | Outer |
|----------|----------------|-----------------|-------|-------|
| 709383 | 150 mm (6 in.) | 1801 2 | 6 | 24 |



ALUMINIUM RULER

NEW ADD

• Metric & SAE

| Item No. | Size | EAN 69426292 | Inner | Outer |
|----------|------------------|-----------------|-------|-------|
| 709511 | 300 mm (12 in.) | 3787 7 | 10 | 100 |
| 709515 | 600 mm (24 in.) | 3788 4 | 10 | 60 |
| 709520 | 1000 mm (39 in.) | 3789 1 | 10 | 60 |

CORNER RULER

• Metric & SAE
• Steel ruler with aluminium handle

| Item No. | Size | EAN 69426292 | Inner | Outer |
|----------|-----------------|-----------------|-------|-------|
| 709404 | 300 mm (12 in.) | 5866 7 | 6 | 24 |

AL RAFTER SQUARE

• Metric & SAE

| Item No. | Size | EAN 69426292 | Inner | Outer |
|----------|----------------|-----------------|-------|-------|
| 709411 | 178 mm (7 in.) | 3953 6 | 20 | 60 |

BOX LEVEL

• accuracy 0.5 mm/m • 3 vials - 0°, 45°, 90°
• Shockproof end caps
• Dual side milled, 1.2 mm thickness

| Item No. | Size | EAN 69426292 | Inner | Outer |
|----------|---------------------|-----------------|-------|-------|
| 710031 | 400 mm (15-3/4 in.) | 8330 0 | 10 | 30 |

BOX LEVEL

• accuracy 0.5 mm/m • 3 vials - 0°, 45°, 90°
• Shockproof end caps
• Dual side milled, 1.2 mm thickness

| Item No. | Size | EAN 69426292 | Inner | Outer |
|----------|---------------------|-----------------|-------|-------|
| 710033 | 600 mm (23-1/2 in.) | 8331 7 | 10 | 30 |
| 710035 | 800 mm (31-1/2 in.) | 8333 1 | 10 | 30 |

3PC CHALK LINE SET

NEW ADD

• 30 m (100 ft.) plastic chalk box
• 113 g (4 oz.) red chalk
• mini line level

| Item No. | Size | EAN 69426292 | Inner | Outer |
|----------|------|-----------------|-------|-------|
| 710702 | 3 pc | 3786 0 | 6 | 24 |

PLASTIC BEVEL

STAINLESS STEEL

• 3 vials - 0°, 45°, 90°
• Aluminum I-beam frame

| Item No. | Size | EAN 69426292 | Inner | Outer |
|----------|--------|-----------------|-------|-------|
| 709423 | 200 mm | 1622 3 | 6 | 24 |



I BEAM LEVEL

• 3 vials - 0°, 45°, 90°
• Aluminum I-beam frame

| Item No. | Size | EAN 69426292 | Inner | Outer |
|----------|----------------------|-----------------|-------|-------|
| 710002 | 450 mm (17-3/4 in.) | 4099 0 | 6 | 24 |
| 710003 | 600 mm (23-1/2 in.) | 3311 4 | 6 | 24 |
| 710004 | 900 mm (35-1/2 in.) | 0225 7 | 6 | 24 |
| 710005 | 1200 mm (47-1/4 in.) | 1616 2 | 6 | 24 |

TORPEDO LEVEL

• 3 vials - 0°, 45°, 90°

| Item No. | Size | EAN 69426292 | Inner | Outer |
|----------|----------------|-----------------|-------|-------|
| 710054 | 152 mm (6 in.) | 9032 2 | 12 | 48 |
| 710055 | 225 mm (9 in.) | 9033 9 | 12 | 48 |

TORPEDO LEVEL

• 3 vials - 0°, 45°, 90°

| Item No. | Size | EAN 69426292 | Inner | Outer |
|----------|----------------|-----------------|-------|-------|
| 710051 | 225 mm (9 in.) | 3312 1 | 6 | 36 |

SNAP OFF KNIFE 9 MM

• 3pc blades included

| Item No. | Size | EAN 69426292 | Inner | Outer |
|----------|------|-----------------|-------|-------|
| 711006 | 9 mm | 5867 4 | 20 | 60 |

BRIDGE LEVEL

• 2 vials - 0°, 90°

| Item No. | Size | EAN 69426292 | Inner | Outer |
|----------|-----------------|-----------------|-------|-------|
| 710012 | 400 mm (16 in.) | 9030 8 | 6 | 36 |

BOX LEVEL

• 3 vials - 0°, 45°, 90°

| Item No. | Size | EAN 69426292 | Inner | Outer |
|----------|---------------------|-----------------|-------|-------|
| 710023 | 600 mm (23-1/2 in.) | 6061 5 | 6 | 24 |

I BEAM LEVEL - PLASTIC

• 3 vials - 0°, 45°, 90°

| Item No. | Size | EAN 69426292 | Inner | Outer |
|----------|------------------|-----------------|-------|-------|
| 710041 | 305 mm (12 in.) | 2892 9 | 0 | 36 |
| 710042 | 406 mm (16 in.) | 2893 6 | 0 | 36 |
| 710043 | 508 mm (20 in.) | 2894 3 | 0 | 36 |
| 710044 | 610 mm (24 in.) | 2895 0 | 0 | 36 |
| 710047 | 1220 mm (48 in.) | 2896 7 | 0 | 24 |

SNAP OFF KNIFE 9 MM

• 3pc blades included

| Item No. | Size | EAN 69426292 | Inner | Outer |
|----------|------|-----------------|-------|-------|
| 711001 | 9 mm | 3313 8 | 6 | 36 |

SNAP OFF KNIFE 18 MM

| Item No. | Size | EAN 69426292 | Inner | Outer |
|----------|-------|-----------------|-------|-------|
| 711003 | 18 mm | 3314 5 | 6 | 36 |

SNAP OFF KNIFE 18 MM

| Item No. | Size | EAN 69426292 | Inner | Outer |
|----------|-------|-----------------|-------|-------|
| 711009 | 18 mm | 5868 1 | 20 | 60 |



HEAVY DUTY UTILITY KNIFE



• 5pc blades included

| Item No. | Size | EAN | Inner | Outer |
|----------|--------------------|----------|--------|-------|
| 71153 | 165 mm (6-1/2 in.) | 69426292 | 3887 4 | 6 24 |

HEAVY DUTY UTILITY KNIFE

NEW ADD



• Unique auto retractable function allows blade to retract automatically when surface contact is lost for safety

| Item No. | Size | EAN | Inner | Outer |
|----------|------|--------|-------|-------|
| 71161 | | 4094 5 | 6 | 36 |

BACK SAW



• 12 tooth / 13 points per inch

| Item No. | Size | EAN | Inner | Outer |
|----------|-----------------|--------|-------|-------|
| 712162 | 300 mm (12 in.) | 5372 3 | 6 | 24 |

HANDSAW



• 7 tooth / 8 points per inch

| Item No. | Size | EAN | Inner | Outer |
|----------|-----------------|--------|-------|-------|
| 712003 | 350 mm (14 in.) | 0923 2 | 6 | 24 |
| 712006 | 450 mm (18 in.) | 6237 4 | 6 | 24 |
| 712009 | 550 mm (22 in.) | 3321 3 | 6 | 24 |

WALL BOARD SAW



• 7 tooth / 8 points per inch

| Item No. | Size | EAN | Inner | Outer |
|----------|----------------|--------|-------|-------|
| 712191 | 150 mm (6 in.) | 3773 0 | 6 | 36 |

FOLDING UTILITY KNIFE



• 10pc blades included

| Item No. | Size | EAN | Inner | Outer |
|----------|------|--------|-------|-------|
| 711102 | | 1945 3 | 6 | 48 |

UTILITY KNIFE



| Item No. | Size | EAN | Inner | Outer |
|----------|----------------|--------|-------|-------|
| 711151 | 150 mm (6 in.) | 3317 6 | 6 | 36 |

SCRAPER WITH 5PC BLADES



| Item No. | Size | EAN | Inner | Outer |
|----------|------|--------|-------|-------|
| 711205 | | 3319 0 | 12 | 72 |

HACKSAW FRAME



• Adjustable to 250 mm (10 in.), 300 mm (12 in.)

| Item No. | Size | EAN | Inner | Outer |
|----------|-----------------|--------|-------|-------|
| 712731 | 300 mm (12 in.) | 0924 9 | 6 | 24 |

HACKSAW FRAME



| Item No. | Size | EAN | Inner | Outer |
|----------|-----------------|--------|-------|-------|
| 712733 | 300 mm (12 in.) | 6063 9 | 6 | 36 |

HEAVY DUTY HACKSAW FRAME



| Item No. | Size | EAN | Inner | Outer |
|----------|-----------------|--------|-------|-------|
| 712735 | 300 mm (12 in.) | 3888 1 | 6 | 24 |

10PC SNAP OFF KNIFE BLADES



| Item No. | Size | EAN | Inner | Outer |
|----------|-------|--------|-------|-------|
| 711075 | 18 mm | 1623 0 | 20 | 60 |

5PC UTILITY KNIFE BLADES



| Item No. | Size | EAN | Inner | Outer |
|----------|------|--------|-------|-------|
| 711185 | | 3318 3 | 12 | 72 |

5PC SCRAPER BLADES



| Item No. | Size | EAN | Inner | Outer |
|----------|------|--------|-------|-------|
| 711215 | 5pc | 3320 6 | 12 | 72 |

JUNIOR HACKSAW



| Item No. | Size | EAN | Inner | Outer |
|----------|----------------|--------|-------|-------|
| 712752 | 150 mm (6 in.) | 6039 4 | 8 | 48 |

MINI HACKSAW FRAME



| Item No. | Size | EAN | Inner | Outer |
|----------|-----------------|--------|-------|-------|
| 712743 | 250 mm (10 in.) | 3322 0 | 6 | 72 |

10PC HACKSAW BLADES



• 4pc 18T, 3pc 24T, 3pc 32T

| Item No. | Size | EAN | Inner | Outer |
|----------|-----------------|--------|-------|-------|
| 712781 | 300 mm (12 in.) | 3323 7 | 10 | 60 |

BOLT CUTTER



| Item No. | Size | EAN | Inner | Outer |
|----------|----------------|--------|-------|-------|
| 713311 | 200 mm (8 in.) | 3331 2 | 6 | 36 |

BOLT CUTTER



| Item No. | Size | EAN | Inner | Outer |
|----------|-----------------|--------|-------|-------|
| 713315 | 350 mm (14 in.) | 0925 6 | 1 | 12 |
| 713317 | 450 mm (18 in.) | 3332 9 | 1 | 10 |
| 713319 | 600 mm (24 in.) | 3333 6 | 1 | 6 |
| 713321 | 750 mm (30 in.) | 3334 3 | 1 | 3 |
| 713323 | 900 mm (36 in.) | 3335 0 | 1 | 2 |



FINISHING TROWEL

NEW ADD



• wood handle

| Item No. | Size | EAN | Inner | Outer |
|----------|--------------|--------|-------|-------|
| 714052 | 280 x 125 mm | 4048 8 | 6 | 24 |

NOTCHED FINISHING TROWEL

NEW ADD

10x10 mm



• wood handle
• square tooth 10 x 10 mm

| Item No. | Size | EAN | Inner | Outer |
|----------|--------------|--------|-------|-------|
| 714054 | 280 x 125 mm | 4052 5 | 6 | 24 |

3PC TROWEL SET



• 180 mm gauging trowel
• 160 mm bucket trowel
• 160 mm brick trowel

| Item No. | Size | EAN | Inner | Outer |
|----------|------|--------|-------|-------|
| 714083 | 3pc | 8672 1 | 6 | 12 |

AVIATION TIN SNIP STRAIGHT CUT



| Item No. | Size | EAN | Inner | Outer |
|----------|-----------------|--------|-------|-------|
| 713101 | 250 mm (10 in.) | 3324 4 | 6 | 24 |

AVIATION TIN SNIP LEFT CUT



| Item No. | Size | EAN | Inner | Outer |
|----------|-----------------|--------|-------|-------|
| 713103 | 250 mm (10 in.) | 3325 1 | 6 | 24 |

AVIATION TIN SNIP RIGHT CUT



| Item No. | Size | EAN | Inner | Outer |
|----------|-----------------|--------|-------|-------|
| 713105 | 250 mm (10 in.) | 3326 8 | 6 | 24 |

POINT TROWEL ROUND EDGE

NEW ADD



• wood handle

| Item No. | Size | EAN | Inner | Outer |
|----------|----------------|--------|-------|-------|
| 714112 | 150 mm (6 in.) | 6599 3 | 10 | 60 |

NOTCHED POINT TROWEL ROUND EDGE

NEW ADD

8x8 mm



• wood handle
• square tooth 8 x 8 mm

| Item No. | Size | EAN | Inner | Outer |
|----------|----------------|--------|-------|-------|
| 714116 | 150 mm (6 in.) | 4047 1 | 10 | 60 |

SUCTION CUP LIFTER

NEW ADD



• max 30 kg

| Item No. | Size | EAN | Inner | Outer |
|----------|--------------------|--------|-------|-------|
| 715701 | 120 mm (4-3/4 in.) | 4095 2 | 6 | 36 |

TIN SNIP



| Item No. | Size | EAN | Inner | Outer |
|----------|-----------------|--------|-------|-------|
| 713151 | 200 mm (8 in.) | 3328 2 | 6 | 24 |
| 713153 | 250 mm (10 in.) | 3329 9 | 6 | 24 |
| 713155 | 300 mm (12 in.) | 3330 5 | 6 | 24 |

DRYWALL TAPING KNIFE



| Item No. | Size | EAN | Inner | Outer |
|----------|--------|--------|-------|-------|
| 714001 | 200 mm | 8673 8 | 10 | 60 |

FINISHING TROWEL



| Item No. | Size | EAN | Inner | Outer |
|----------|--------------|--------|-------|-------|
| 714012 | 280 x 125 mm | 8670 7 | 6 | 24 |

PAINTING ROLLER

NEW ADD



• with acrylic sleeve

| Item No. | Size | EAN | Inner | Outer |
|----------|----------------|--------|-------|-------|
| 718301 | 100 mm (4 in.) | 3748 8 | 0 | 50 |

PAINTING ROLLER

NEW ADD



• with acrylic sleeve

| Item No. | Size | EAN | Inner | Outer |
|----------|----------------|--------|-------|-------|
| 718303 | 180 mm (7 in.) | 3762 4 | 0 | 36 |
| 718305 | 228 mm (9 in.) | 3763 1 | 0 | 36 |

DUAL SUCTION CUP LIFTER

NEW ADD



• max 60 kg

| Item No. | Size | EAN | Inner | Outer |
|----------|--------------------|--------|-------|-------|
| 715702 | 120 mm (4-3/4 in.) | 4096 9 | 6 | 24 |

5PC ROLLER SET

- 100 mm (4 in.) black plastic tray
- 100 mm (4 in.) acrylic mini roller
- 100 mm (4 in.) foam mini roller
- 175 mm (7 in.) plastic mix paint sticks
- 100 mm (4 in.) x 254 mm (10 in.) roller frame with 6 mm zinc plated pole

| Item No. | Size | EAN 69426292 | Inner | Outer |
|----------|------|-----------------|-------|-------|
| 718405 | 5pc | 5039 5 | 20 | 60 |

SKELETON CAULKING GUN

| Item No. | Size | EAN 69426292 | Inner | Outer |
|----------|----------------|-----------------|-------|-------|
| 718801 | 225 mm (9 in.) | 1556 1 | 6 | 24 |

CAULKING GUN

NEW ADD

| Item No. | Size | EAN 69426292 | Inner | Outer |
|----------|----------------|-----------------|-------|-------|
| 718802 | 225 mm (9 in.) | 4965 8 | 6 | 24 |

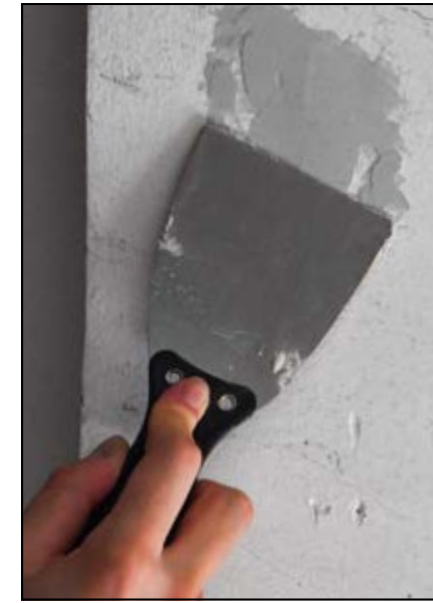

PUTTY KNIFE FLEXIBLE

| Item No. | Size | EAN 69426292 | Inner | Outer |
|----------|--------------------|-----------------|-------|-------|
| 721001 | 38 mm (1-1/2 in.) | 3173 8 | 24 | 96 |
| 721003 | 75 mm (3 in.) | 3174 5 | 24 | 96 |
| 721005 | 115 mm (4-1/2 in.) | 3175 2 | 24 | 96 |
| 721007 | 150 mm (6 in.) | 3176 9 | 24 | 96 |

PUTTY KNIFE STIFF

| Item No. | Size | EAN 69426292 | Inner | Outer |
|----------|-------------------|-----------------|-------|-------|
| 721051 | 38 mm (1-1/2 in.) | 3177 6 | 24 | 96 |
| 721053 | 75 mm (3 in.) | 3178 3 | 24 | 96 |

PAINT MIXER

NEW ADD

| Item No. | Size | EAN 69426292 | Inner | Outer |
|----------|--------------|-----------------|-------|-------|
| 718821 | 400 x 80 mm | 1614 8 | 6 | 24 |
| 718823 | 600 x 100 mm | 1557 8 | 6 | 24 |

CARPENTER PENCIL

- Round flat square side to prevent rolling

| Item No. | Size | EAN 69426292 | Inner | Outer |
|----------|----------------|-----------------|-------|-------|
| 719001 | 175 mm (7 in.) | 1815 9 | 0 | 400 |



3PC PLASTIC PUTTY KNIFE SET

- 50 mm (2 in.), 100 mm (4 in.), 150 mm (6 in.)

| Item No. | Size | EAN 69426292 | Inner | Outer |
|----------|------|-----------------|-------|-------|
| 721323 | 3pc | 3184 4 | 12 | 72 |

PLASTIC PUTTY KNIFE

| Item No. | Size | EAN 69426292 | Inner | Outer |
|----------|----------------|-----------------|-------|-------|
| 721302 | 50 mm (2 in.) | 3181 3 | 24 | 96 |
| 721304 | 100 mm (4 in.) | 3182 0 | 24 | 96 |
| 721306 | 150 mm (6 in.) | 3183 7 | 24 | 96 |

3PC PUTTY KNIFE SET FLEXIBLE

- 38 mm (1-1/2 in.), 50 mm (2 in.), 75 mm (3 in.)

| Item No. | Size | EAN 69426292 | Inner | Outer |
|----------|------|-----------------|-------|-------|
| 721343 | 3pc | 8671 4 | 6 | 24 |

3 PC FILE SET

- flat, round, half round
- #2 second cut

| Item No. | Size | EAN 69426292 | Inner | Outer |
|----------|--------|-----------------|-------|-------|
| 720103 | 200 mm | 0450 3 | 6 | 12 |

6PC FILE SET

- 2pc handle
- 200 mm (8 in.) mill file, 200 mm (8 in.) half round file, 150 mm (6 in.) triangle file, 150 mm (6 in.) mill file

| Item No. | Size | EAN 69426292 | Inner | Outer |
|----------|------|-----------------|-------|-------|
| 720106 | 6pc | 3336 7 | 6 | 12 |

6 PC NEEDLE FILE SET

- tri-angle, equalling, round, half round, square, flat

| Item No. | Size | EAN 69426292 | Inner | Outer |
|----------|------|-----------------|-------|-------|
| 720206 | 6pc | 0213 4 | 12 | 36 |

PUTTY KNIFE FLEXIBLE

NEW ADD

| Item No. | Size | EAN 69426292 | Inner | Outer |
|----------|-------------------|-----------------|-------|-------|
| 721331 | 38 mm (1-1/2 in.) | 4150 8 | 10 | 60 |
| 721332 | 50 mm (2 in.) | 5563 5 | 10 | 60 |
| 721333 | 75 mm (3 in.) | 7117 8 | 10 | 60 |
| 721334 | 100 mm (4 in.) | 7118 5 | 10 | 60 |

PUTTY KNIFE STIFF

NEW ADD

| Item No. | Size | EAN 69426292 | Inner | Outer |
|----------|-------------------|-----------------|-------|-------|
| 721351 | 38 mm (1-1/2 in.) | 7119 2 | 10 | 60 |
| 721353 | 75 mm (3 in.) | 3772 3 | 10 | 60 |

WIRE BRUSH

- 4 x 18 wires

| Item No. | Size | EAN 69426292 | Inner | Outer |
|----------|--------------------|-----------------|-------|-------|
| 724003 | 165 mm (6-1/2 in.) | 3337 4 | 6 | 24 |

WIRE BRUSH STEEL

STEEL

| Item No. | Size | EAN | Inner | Outer |
|----------|----------------|----------|-------|-------|
| 724051 | 250 mm (10 in) | 69426292 | 12 | 144 |

WIRE BRUSH BRASS COATED

STEEL & BRASS

| Item No. | Size | EAN | Inner | Outer |
|----------|----------------|--------|-------|-------|
| 724052 | 250 mm (10 in) | 5637 3 | 12 | 144 |

WIRE BRUSH NYLON

NYLON

| Item No. | Size | EAN | Inner | Outer |
|----------|----------------|--------|-------|-------|
| 724053 | 250 mm (10 in) | 5638 0 | 12 | 144 |

3 PC MINI BRUSH SET

• 180 mm (7 in.)
• Stainless steel, brass, nylon

| Item No. | Size | EAN | Inner | Outer |
|----------|------|--------|-------|-------|
| 724013 | 3 pc | 6066 0 | 12 | 72 |

WIRE BRUSH STAINLESS STEEL

STAINLESS STEEL

| Item No. | Size | EAN | Inner | Outer |
|----------|----------------|--------|-------|-------|
| 724054 | 250 mm (10 in) | 5639 7 | 12 | 144 |

WIRE BRUSH BRASS

BRASS

| Item No. | Size | EAN | Inner | Outer |
|----------|----------------|--------|-------|-------|
| 724055 | 250 mm (10 in) | 5640 3 | 12 | 144 |

WOOD HANDLE WIRE BRUSH

• 4 x 16 wires

| Item No. | Size | EAN | Inner | Outer |
|----------|-----------------|--------|-------|-------|
| 724104 | 280 mm (11 in.) | 3338 1 | 12 | 48 |

PIPE WRENCH

| Item No. | Size | EAN | Inner | Outer |
|----------|-----------------|--------|-------|-------|
| 730001 | 200 mm (8 in.) | 3339 8 | 6 | 36 |
| 730003 | 250 mm (10 in.) | 3340 4 | 6 | 12 |
| 730005 | 350 mm (14 in.) | 3341 1 | 4 | 8 |
| 730007 | 450 mm (18 in.) | 3342 8 | 2 | 4 |
| 730009 | 600 mm (24 in.) | 3343 5 | 2 | 4 |
| 730011 | 900 mm (36 in.) | 3344 2 | 1 | 2 |

MINI TUBE CUTTER

NEW ADD

| Item No. | Size | EAN | Inner | Outer |
|----------|--------------------------|--------|-------|-------|
| 730101 | 3 - 22mm (1/8 - 7/8 in.) | 9408 5 | 6 | 60 |

TUBE CUTTER

NEW ADD

| Item No. | Size | EAN | Inner | Outer |
|----------|----------------------------|--------|-------|-------|
| 730105 | 3 - 30mm (1/8 - 1-1/8 in.) | 9409 2 | 6 | 36 |

2PC TUBE CUTTER BLADE 3-30MM

NEW ADD

• for 730105

| Item No. | Size | EAN | Inner | Outer |
|----------|------|--------|-------|-------|
| 730106 | 2 pc | 4966 5 | 10 | 60 |

PVC PIPE CUTTER

NEW ADD

| Item No. | Size | EAN | Inner | Outer |
|----------|-------------------|--------|-------|-------|
| 730121 | 36 mm (1-3/8 in.) | 8281 5 | 20 | 120 |

PVC PIPE CUTTER

NEW ADD

| Item No. | Size | EAN | Inner | Outer |
|----------|-------------------|--------|-------|-------|
| 730123 | 42 mm (1-5/8 in.) | 9442 9 | 6 | 24 |

RATCHET HANDLE QUICK RELEASE

NEW ADD

CR-MO 72T

| Item No. | Size | EAN | Inner | Outer |
|----------|-------------|--------|-------|-------|
| 733001 | 1/4 in. Dr. | 4897 2 | 6 | 48 |
| 733051 | 3/8 in. Dr. | 4967 2 | 6 | 36 |
| 733101 | 1/2 in. Dr. | 4899 6 | 6 | 24 |

EXTENDING RATCHET HANDLE QUICK RELEASE

NEW ADD

CR-MO 72T

| Item No. | Size | EAN | Inner | Outer |
|----------|-------------|--------|-------|-------|
| 733004 | 1/4 in. Dr. | 9047 6 | 6 | 48 |
| 733054 | 3/8 in. Dr. | 9049 0 | 6 | 24 |
| 733104 | 1/2 in. Dr. | 9050 6 | 4 | 16 |

12PC SOCKET SET - 1/4 in. DR.

1/4 6

• 734011: 4, 5, 6, 7, 8, 9, 10, 11, 12, 13 mm;
70 mm (3 in.) extension bar; ratchet handle
• 734013: 5/32, 3/16, 1/4, 9/32, 5/16, 11/32, 3/8, 7/16, 15/32, 1/2 in.; 70 mm (3 in.) extension bar; ratchet handle

| Item No. | Size | EAN | Inner | Outer |
|----------|--------|--------|-------|-------|
| 734011 | METRIC | 4223 9 | 10 | 40 |
| 734013 | SAE | 2670 3 | 10 | 40 |

12PC SOCKET SET - 3/8 in. DR.

3/8 6

• 734111: 10, 11, 12, 13, 14, 15, 17, 19, 22, 24 mm;
70 mm (3 in.) extension bar; ratchet handle
• 734113: 3/8, 7/16, 15/32, 1/2, 9/16, 5/8, 11/16, 3/4, 7/8, 15/16 in.; 70 mm (3 in.) extension bar; ratchet handle

| Item No. | Size | EAN | Inner | Outer |
|----------|--------|--------|-------|-------|
| 734111 | METRIC | 4242 0 | 5 | 20 |
| 734113 | SAE | 2671 0 | 5 | 20 |

12PC SOCKET SET - 1/2 in. DR.

1/2 6

• 734211: 10, 11, 12, 13, 14, 15, 17, 19, 21, 24 mm;
120 mm (5 in.) extension bar; ratchet handle
• 734213: 3/8, 7/16, 15/32, 1/2, 9/16, 5/8, 11/16, 3/4, 7/8, 15/16 in.; 120 mm (5 in.) extension bar; ratchet handle

| Item No. | Size | EAN | Inner | Outer |
|----------|--------|--------|-------|-------|
| 734211 | METRIC | 4243 7 | 5 | 10 |
| 734213 | SAE | 2672 7 | 5 | 10 |

21PC SOCKET SET - 1/4 in. DR.



- 1/4 in. DR. ratchet handle
- Metric: 5, 6, 7, 8, 9, 10, 11, 12, 13 & 14 mm
- SAE: 3/16, 7/32, 1/4, 9/32, 5/16, 11/32, 3/8, 7/16, 1/2 & 9/16 in.

| Item No. | Size | EAN | Inner | Outer |
|----------|------|--------|-------|-------|
| 734021 | 21pc | 0936 2 | 6 | 36 |

21PC SOCKET SET - 3/8 in. DR.

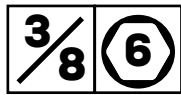

- 3/8 in. DR. ratchet handle
- Metric: 10, 11, 12, 13, 14, 15, 16, 17, 19 & 22 mm
- SAE: 5/16, 3/8, 7/16, 1/2, 9/16, 5/8, 11/16, 3/4, 13/16 & 7/8 in.

| Item No. | Size | EAN | Inner | Outer |
|----------|------|--------|-------|-------|
| 734121 | 21pc | 0937 9 | 6 | 12 |

21PC SOCKET SET - 1/2 in. DR.

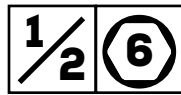

- 1/2 in. DR. ratchet handle
- Metric: 10, 11, 12, 13, 14, 15, 17, 19, 22 & 24 mm
- SAE: 3/8, 7/16, 1/2, 9/16, 5/8, 11/16, 3/4, 13/16, 7/8 & 15/16 in.

| Item No. | Size | EAN | Inner | Outer |
|----------|------|--------|-------|-------|
| 734221 | 21pc | 0938 6 | 6 | 12 |

40PC SOCKET SET - 1/4 & 3/8 in. DR.



- 23pc 1/4 in. DR. 6PT socket: SAE- 5/32, 3/16, 7/32, 1/4, 9/32, 5/16, 11/32, 3/8, 13/32, 7/16, 15/32 in.; Metric- 4, 4.5, 5, 5.5, 6, 7, 8, 9, 10, 11, 12, 13 mm; • 7pc 3/8 in. DR. 6PT socket: SAE- 1/2, 9/16, 5/8, 3/4 in.; Metric- 14, 16, 17 mm; • 3pc 1/4 in. DR. 8PT socket: SAE- 1/4, 5/16, 3/8 in.; • 3/8 in. DR. ratchet handle; • 3/8 in. (F) x 1/4 in. (M) adaptor; • 3/8 in. DR. 70 mm extension bar; • 3/8 in. DR. 16 mm (5/8 in.) spark plug socket; • 1/4 in. DR. spinner handle; • speed disc

| Item No. | Size | EAN | Inner | Outer |
|----------|------|--------|-------|-------|
| 734440 | 40pc | 0939 3 | 0 | 10 |

52PC SOCKET SET - 1/4, 3/8 & 1/2 in. DR.



- 25pc 1/4 in. DR. 6PT socket: SAE- 1/2, 15/32, 7/16, 13/32, 3/8, 11/32, 5/16, 9/32, 1/4, 7/32, 3/16, 5/32 in.; Metric- 4, 4.5, 5, 5.5, 6, 6.5, 7, 8, 9, 10, 11, 12, 13 mm; • 3pc 1/4 in. DR. 8PT socket: SAE- 3/8, 5/16, 1/4 in.; • 6pc 3/8 in. DR. 6PT socket: SAE- 9/16, 1/2, 7/16 in.; Metric- 11, 12, 13 mm; • 4pc 1/2 in. DR. 6PT socket: SAE- 5/8, 11/16, 3/4, 13/16 in.; • 1/4 in. DR. spinner handle; • 1/4 in. DR. socket bit holder; • 3/8 in. DR. ratchet handle; • 3/8 in. (F) x 1/4 in. (M) adaptor; • 3/8 in. DR. 70 mm extension bar; • 3/8 in. DR. 16 mm (5/8 in.) spark plug socket; • 1/2 in. DR. ratchet handle; • 5pc bit; • speed disc

| Item No. | Size | EAN | Inner | Outer |
|----------|------|--------|-------|-------|
| 734452 | 52pc | 0940 9 | 0 | 6 |

52PC SOCKET SET - 1/4 & 1/2 in. DR.



- 11pc 1/4 in. DR. 6PT socket: 4, 4.5, 5, 6, 7, 8, 9, 10, 11, 12, 13 mm; • 13pc 1/2 in. DR. 6PT socket: 10, 11, 12, 13, 14, 15, 17, 19, 22, 24, 27, 30, 32 mm; • 1/4 in. DR. x 70 mm extension bar; • 1/4 in. DR. ratchet handle; • 1/4 in. DR. socket bit holder; • 2pc universal joint 1/4 in. DR. & 1/2 in. DR.; • 2pc sliding T-bar 1/4 in. DR. & 1/2 in. DR.; • 1/4 in. DR. bit/socket adaptor; • 1/2 in. DR. 21 mm spark plug socket; • 2pc 1/2 in. DR. extension bar 120 & 245 mm; • 1/2 in. DR. ratchet handle; • 12pc bits; • 3pc hex key: 1.5, 2, 2.5 mm; • magnetic ratchet screwdriver handle

| Item No. | Size | EAN | Inner | Outer |
|----------|------|--------|-------|-------|
| 734453 | 52pc | 8677 6 | 0 | 6 |

21PC SOCKET SET - 1/4 & 3/8 in. DR.



- 11pc 1/4 in. DR. 6PT socket: 4, 4.5, 5, 5.5, 6, 7, 8, 9, 10, 11, 12 mm
- 1/4 in. DR. spinner handle
- 3/8 in. DR. 16 mm (5/8 in.) spark plug socket
- 3pc 3/8 in. DR. 6PT socket: 13, 14, 17 mm
- 3/8 in. DR. ratchet handle
- 3/8 in. (F) x 1/4 in. (M) adaptor
- 3/8 in. DR. extension bar
- speed disc

| Item No. | Size | EAN | Inner | Outer |
|----------|------|--------|-------|-------|
| 734421 | 21pc | 4804 0 | 2 | 12 |

15PC SOCKET SET - 3/4 in. DR.



- 10pc 3/4 in. DR. 6PT socket: 22, 24, 27, 30, 32, 36, 38, 41, 46, 50 mm
- 3/4 in. DR. ratchet handle
- 3/4 in. DR. extension bar 200 mm
- 3/4 in. DR. extension bar 100 mm
- 3/4 in. DR. sliding T-bar 450 mm

| Item No. | Size | EAN | Inner | Outer |
|----------|--------|--------|-------|-------|
| 734515 | METRIC | 4867 5 | 0 | 2 |

21PC SOCKET SET - 3/4 in. DR.



- 16pc 3/4 in. DR. 12PT socket: 7/8, 15/16, 1, 1-1/16, 1-1/8, 1-3/16, 1-1/4, 1-5/16, 1-3/8, 1-7/16, 1-1/2, 1-5/8, 1-3/4, 1-13/16, 1-7/8, 2 in.
- 3/4 in. DR. ratchet handle
- 3/4 in. DR. extension bar 8 in.
- 3/4 in. DR. extension bar 4 in.
- 3/4 in. DR. sliding T-bar 18 in.

| Item No. | Size | EAN | Inner | Outer |
|----------|------|--------|-------|-------|
| 734521 | SAE | 4805 7 | 0 | 2 |

215 PC SOCKET SET - 1/4, 3/8 & 1/2 in. DR.



- 1/4 in. Dr.: • 13 pc socket 4, 4.5, 5, 5.5, 6, 7, 8, 9, 10, 11, 12, 13, 14 mm; • 5 pc E socket E4, E5, E6, E7, E8; • 7 pc deep socket 4, 5, 6, 7, 8, 9, 10 mm; • 1 pc sliding T bar; • 2 pc extension bar 50 & 100 mm; • 1 pc bit holder; • 1 pc universal joint; • 1 pc spinner handle; • 1 pc 72T ratchet handle; • 30 pc bit socket PH #0, #1, #2, PZ #0, #1, #2, Slot 4, 5.5, 6.5, 7 mm, HEX 3, 4, 5, 6 mm, Torx 8, 9, 10, 15, 20, 25, 27, 30. Torx temper 8, 9, 10, 15, 20, 25, 27, 30;

- 3/8 in. Dr.: • 10 pc socket 10, 11, 12, 13, 14, 15, 16, 17, 18, 19 mm; • 6 pc E socket E10, E11, E12, E14, E16, E18; • 6 pc deep socket 10, 11, 12, 13, 14, 15 mm; • 1 pc spark plug socket 21 mm; • 1 pc bit holder; • 1 pc universal joint; • 1 pc extension bar 125 mm; • 1 pc 72T ratchet handle;

- 1/2 in. Dr.: • 14 pc socket 13, 14, 15, 16, 17, 18, 19, 20, 21, 22, 24, 27, 30, 32 mm; • 3 pc E socket E20, E22, E24; • 5 pc deep socket 16, 17, 18, 19, 22 mm; • 2 pc extension bar 125 & 250 mm; • 1 pc 3-way adaptor 3/8 in. (F) x 1/2 in. (M); • 1 pc universal joint; • 1 pc bit holder; • 2 pc spark plug socket 16 & 21 mm; • 1 pc 72T ratchet handle; • 2 pc bit socket T-55, T-60.

- 30 pc bits (8 mm): HEX 5.5, 6, 6.5, 7, 8, 10, 12 mm, Slot 6, 6.5, 8 mm, PH #3, #4, PZ #3, #4, TORX 27, 30, 35, 40, 45, 50, Torx temper 27, 30, 35, 40, 45, 50, M5, M6, M8, M10; • 12 pc combination wrench 8, 9, 10, 11, 12, 13, 14, 15, 16, 17, 18, 19 mm; • 7 pc hex key 1.27, 1.5, 2, 2.5, 3, 4, 5 mm; • 44 pc bits (6.35 mm): M5, M6, M8, M10, M12; PH #0, #1, #2, #3, PZ #0, #1, #2, #3, Slot 4, 5.5, 6.5, 7 mm; HEX 2, 2.5, 3, 4, 5, 6, 7 mm; SP 4, 6, 8, 10, TW 1, 2, 3, 4; Torx temper 8, 10, 15, 20, 25, 27, 30, 40, 45; TO 6, 8, 10; • 1 pc screwdriver driver; • 1 pc BMC

| Item No. | Size | EAN | Inner | Outer |
|----------|--------|--------|-------|-------|
| 734603 | 215 pc | 4132 4 | 0 | 2 |

5PC COMBINATION WRENCH SET

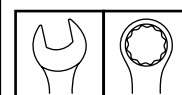

- 735203: 8, 10, 12, 14 & 17 mm
- 735213: 3/8, 7/16, 1/2, 9/16 & 5/8 in.

| Item No. | Size | EAN | Inner | Outer |
|----------|--------|--------|-------|-------|
| 735203 | METRIC | 0941 6 | 6 | 24 |
| 735213 | SAE | 0943 0 | 6 | 24 |

9PC COMBINATION WRENCH SET

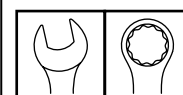

- 735205: 6, 8, 9, 10, 12, 13, 15, 17 & 19 mm
- 735215: 1/4, 5/16, 3/8, 7/16, 1/2, 9/16, 5/8, 11/16 & 3/4 in.

| Item No. | Size | EAN | Inner | Outer |
|----------|--------|--------|-------|-------|
| 735205 | METRIC | 0942 3 | 6 | 18 |
| 735215 | SAE | 0944 7 | 6 | 18 |

22PC COMBINATION WRENCH



- Tool roll included
- Metric: 6, 7, 8, 9, 10, 11, 12, 13, 14, 17, 19 mm
- SAE: 1/4, 5/16, 3/8, 7/16, 1/2, 9/16, 5/8, 11/16, 3/4, 13/16, 7/8 in.

| Item No. | Size | EAN | Inner | Outer |
|----------|------|--------|-------|-------|
| 735222 | 22pc | 4159 1 | 0 | 4 |

14PC COMBINATION WRENCH SET



- 8, 9, 10, 11, 12, 13, 14, 15, 16, 17, 18, 19, 22, 24 mm
- nylon tool roll included

| Item No. | Size | EAN | Inner | Outer |
|----------|-------|--------|-------|-------|
| 735220 | 14 pc | 6241 1 | 0 | 6 |

COMBINATION WRENCHES-METRIC



| Item No. | Size | EAN | Inner | Outer |
|----------|-------|--------|-------|-------|
| 735006 | 6 mm | 4900 9 | 6 | 72 |
| 735007 | 7 mm | 0145 8 | 6 | 72 |
| 735008 | 8 mm | 3895 9 | 6 | 72 |
| 735009 | 9 mm | 3896 6 | 6 | 72 |
| 735010 | 10 mm | 3897 3 | 6 | 72 |
| 735011 | 11 mm | 3898 0 | 6 | 72 |
| 735012 | 12 mm | 3899 7 | 6 | 72 |
| 735013 | 13 mm | 3900 0 | 6 | 72 |
| 735014 | 14 mm | 3901 7 | 6 | 72 |
| 735015 | 15 mm | 3902 4 | 6 | 72 |
| 735016 | 16 mm | 3903 1 | 6 | 72 |
| 735017 | 17 mm | 3904 8 | 6 | 72 |
| 735018 | 18 mm | 3905 5 | 6 | 48 |
| 735019 | 19 mm | 3906 2 | 6 | 48 |
| 735020 | 20 mm | 3907 9 | 6 | 48 |
| 735021 | 21 mm | 3908 6 | 6 | 48 |
| 735022 | 22 mm | 3909 3 | 6 | 48 |
| 735023 | 23 mm | 0146 5 | 6 | 48 |
| 735024 | 24 mm | 3910 9 | 6 | 48 |
| 735025 | 25 mm | 0147 2 | 6 | 48 |
| 735026 | 26 mm | 0148 9 | 6 | 36 |
| 735027 | 27 mm | 3911 6 | 6 | 36 |
| 735028 | 28 mm | 7151 2 | 6 | 24 |
| 735029 | 29 mm | 7152 9 | 6 | 24 |
| 735030 | 30 mm | 7153 6 | 6 | 24 |
| 735032 | 32 mm | 7154 3 | 6 | 24 |

COMBINATION WRENCHES-SAE



| Item No. | Size | EAN | Inner | Outer |
|----------|------------|--------|-------|-------|
| 735105 | 1/4 in. | 3944 4 | 6 | 72 |
| 735106 | 5/16 in. | 3945 1 | 6 | 72 |
| 735107 | 3/8 in. | 3946 8 | 6 | 72 |
| 735108 | 7/16 in. | 3912 3 | 6 | 72 |
| 735109 | 1/2 in. | 3913 0 | 6 | 72 |
| 735110 | 9/16 in. | 3914 7 | 6 | 72 |
| 735111 | 5/8 in. | 3915 4 | 6 | 72 |
| 735112 | 11/16 in. | 3916 1 | 6 | 48 |
| 735113 | 3/4 in. | 3917 8 | 6 | 48 |
| 735114 | 13/16 in. | 3918 5 | 6 | 48 |
| 735115 | 7/8 in. | 3919 2 | 6 | 48 |
| 735116 | 15/16 in. | 3920 8 | 6 | 48 |
| 735117 | 1 in. | 3921 5 | 6 | 48 |
| 735118 | 1-1/16 in. | 3922 2 | 6 | 48 |
| 735119 | 1-1/8 in. | 3923 9 | 6 | 36 |
| 735120 | 1-1/4 in. | 3924 6 | 6 | 36 |
| 735122 | 1-3/8 in. | 3925 3 | 6 | 24 |
| 735124 | 1-5/16 in. | 3926 0 | 6 | 24 |
| 735126 | 1-7/16 in. | 3927 7 | 6 | 12 |
| 735128 | 1-1/2 in. | 3928 4 | 6 | 12 |
| 735130 | 1-3/4 in. | 3929 1 | 6 | 12 |

RATCHET WRENCH-METRIC

72T NEW ADD

| Item No. | Size | EAN 69426292 | Inner | Outer |
|----------|-------|-----------------|-------|-------|
| 735408 | 8 mm | 0149 6 | 6 | 48 |
| 735409 | 9 mm | 5143 9 | 6 | 48 |
| 735410 | 10 mm | 2986 5 | 6 | 48 |
| 735411 | 11 mm | 4055 6 | 6 | 48 |
| 735412 | 12 mm | 4057 0 | 6 | 48 |
| 735413 | 13 mm | 4058 7 | 6 | 48 |
| 735414 | 14 mm | 4065 5 | 6 | 48 |
| 735415 | 15 mm | 4066 2 | 6 | 48 |
| 735416 | 16 mm | 6006 6 | 6 | 48 |
| 735417 | 17 mm | 5608 3 | 6 | 48 |
| 735418 | 18 mm | 4071 6 | 6 | 48 |
| 735419 | 19 mm | 4072 3 | 6 | 48 |

FLEX RATCHET WRENCH

72T NEW ADD

| Item No. | Size | EAN 69426292 | Inner | Outer |
|----------|-------|-----------------|-------|-------|
| 735608 | 8 mm | 5935 0 | 6 | 48 |
| 735609 | 9 mm | 5937 4 | 6 | 48 |
| 735610 | 10 mm | 5940 4 | 6 | 48 |
| 735611 | 11 mm | 0226 4 | 6 | 48 |
| 735612 | 12 mm | 0229 5 | 6 | 48 |
| 735613 | 13 mm | 0232 5 | 6 | 48 |
| 735614 | 14 mm | 0234 9 | 6 | 48 |
| 735615 | 15 mm | 6111 7 | 6 | 48 |
| 735616 | 16 mm | 6112 4 | 6 | 48 |
| 735617 | 17 mm | 6113 1 | 6 | 48 |
| 735618 | 18 mm | 6114 8 | 6 | 48 |
| 735619 | 19 mm | 6115 5 | 6 | 48 |
| 735622 | 22 mm | 6118 6 | 6 | 48 |

DOUBLE OPEN WRENCH

NEW ADD

| Item No. | Size | EAN 69426292 | Inner | Outer |
|----------|------------|-----------------|-------|-------|
| 735801 | 6 x 7 mm | 6242 8 | 6 | 72 |
| 735802 | 8 x 9 mm | 6243 5 | 6 | 72 |
| 735803 | 10 x 11 mm | 6244 2 | 6 | 72 |
| 735804 | 12 x 13 mm | 5625 0 | 6 | 72 |
| 735805 | 14 x 15 mm | 3704 4 | 6 | 72 |
| 735806 | 16 x 17 mm | 7130 7 | 6 | 72 |
| 735807 | 18 x 19 mm | 4043 3 | 6 | 48 |
| 735808 | 20 x 22 mm | 4035 8 | 6 | 48 |
| 735809 | 21 x 23 mm | 4037 2 | 6 | 48 |
| 735810 | 24 x 26 mm | 4185 0 | 6 | 36 |
| 735811 | 25 x 28 mm | 4186 7 | 6 | 24 |
| 735812 | 30 x 32 mm | 4188 1 | 6 | 12 |

2PC BUNGEE CORD RED

NEW ADD

| Item No. | Size | EAN 69426292 | Inner | Outer |
|----------|--------------|-----------------|-------|-------|
| 737331 | 60 cm x 8 mm | 3738 9 | 12 | 72 |

2PC BUNGEE CORD GREEN

NEW ADD

| Item No. | Size | EAN 69426292 | Inner | Outer |
|----------|--------------|-----------------|-------|-------|
| 737332 | 80 cm x 8 mm | 4023 5 | 12 | 72 |

6PC BUNGEE CORD

• include 1 pc 81 cm, 1 pc 61 cm, 2 pc 45 cm, 2pc 25 cm mini

| Item No. | Size | EAN 69426292 | Inner | Outer |
|----------|------|-----------------|-------|-------|
| 737318 | 6pc | 1916 3 | 6 | 36 |

RATCHET WRENCH-SAE

72T NEW ADD

| Item No. | Size | EAN 69426292 | Inner | Outer |
|----------|-----------|-----------------|-------|-------|
| 735453 | 5/16 in. | 4073 0 | 6 | 48 |
| 735454 | 3/8 in. | 4074 7 | 6 | 48 |
| 735455 | 7/16 in. | 4075 4 | 6 | 48 |
| 735456 | 1/2 in. | 4077 8 | 6 | 48 |
| 735457 | 9/16 in. | 4078 5 | 6 | 48 |
| 735458 | 5/8 in. | 4079 2 | 6 | 48 |
| 735459 | 11/16 in. | 4080 8 | 6 | 48 |
| 735460 | 3/4 in. | 5934 3 | 6 | 48 |



7PC DOUBLE OPEN WRENCH SET

NEW ADD

• 8 x 9, 10 x 11, 12 x 13, 14 x 15, 16 x 17, 18 x 19 & 21 x 23 mm
• nylon tool roll included

| Item No. | Size | EAN 69426292 | Inner | Outer |
|----------|------|-----------------|-------|-------|
| 735827 | 7 pc | 4189 8 | 0 | 12 |

2PC BUNGEE CORD YELLOW

NEW ADD

| Item No. | Size | EAN 69426292 | Inner | Outer |
|----------|---------------|-----------------|-------|-------|
| 737333 | 100 cm x 8 mm | 4024 2 | 12 | 72 |

BUNGEE CORD 6 ARM

NEW ADD

| Item No. | Size | EAN 69426292 | Inner | Outer |
|----------|--------------|-----------------|-------|-------|
| 737352 | 60 cm x 8 mm | 4026 6 | 12 | 72 |

MAGNETIC TRAY

STAINLESS STEEL

| Item No. | Size | EAN 69426292 | Inner | Outer |
|----------|----------------|-----------------|-------|-------|
| 739623 | 150 mm (6 in.) | 3934 5 | 6 | 24 |

RATCHET TIE DOWN

• Load capacity 750kg
• Max 1500 kg

| Item No. | Size | EAN 69426292 | Inner | Outer |
|----------|-------------|-----------------|-------|-------|
| 737111 | 6 m x 25 mm | 4584 1 | 10 | 20 |

RATCHET TIE DOWN

• Load capacity 1000kg
• Max 2000 kg

| Item No. | Size | EAN 69426292 | Inner | Outer |
|----------|--------------|-----------------|-------|-------|
| 737123 | 10 m x 35 mm | 4585 8 | 0 | 10 |

RATCHET TIE DOWN

• Load capacity 1500kg
• Max 3000 kg

| Item No. | Size | EAN 69426292 | Inner | Outer |
|----------|--------------|-----------------|-------|-------|
| 737131 | 6 m x 50 mm | 4586 5 | 0 | 8 |
| 737133 | 10 m x 50 mm | 4587 2 | 0 | 6 |

TIRE GAUGE

| Item No. | Size | EAN 69426292 | Inner | Outer |
|----------|------------|-----------------|-------|-------|
| 739110 | 10-100 PSI | 3989 5 | 12 | 144 |

TIRE GAUGE

| Item No. | Size | EAN 69426292 | Inner | Outer |
|----------|-----------|-----------------|-------|-------|
| 739111 | 10-50 PSI | 3990 1 | 12 | 144 |

TIRE GAUGE

| Item No. | Size | EAN 69426292 | Inner | Outer |
|----------|------------|-----------------|-------|-------|
| 739112 | 10-120 PSI | 3991 8 | 12 | 144 |

4PC SCRAPER SET

NEW ADD



- 6 mm (1/4 in.) x 302 mm;
- 12.5 mm (1/2 in.) x 302 mm;
- 25 mm (1 in.) x 210 mm;
- 25 mm (1 in.) x 310 mm

| Item No. | Size | EAN | Inner | Outer |
|----------|------|-----------------|-------|-------|
| 739684 | 4 pc | 69426292 4013 6 | 6 | 24 |

6PC SCRAPER AND REMOVER SET

NEW ADD



- scrapers 12.5 mm (1/2 in.), 25 mm (1 in.)
- hooks straight, 45°, 90°, 180°

| Item No. | Size | EAN | Inner | Outer |
|----------|------|-----------------|-------|-------|
| 739696 | 6 pc | 69426292 4014 3 | 6 | 24 |

TELESCOPING MAGNETIC PICKUP TOOL



- extends to 850 mm (33-1/2 in.)

| Item No. | Size | EAN | Inner | Outer |
|----------|---------------|-----------------|-------|-------|
| 739633 | 8 lb. (3.6kg) | 69426292 3935 2 | 6 | 24 |

TERMINAL CRIMPING TOOL

NEW ADD



- Crimping insulated terminals:
red 0.5-1 mm² (#18-#20 AWG),
blue 1.5-2.5 mm² (#14-#16 AWG),
yellow 4-6 mm² (#10-#12 AWG).

| Item No. | Size | EAN | Inner | Outer |
|----------|------|-----------------|-------|-------|
| 741051 | | 69426292 4005 1 | 6 | 24 |

VOLTAGE DETECTOR

NEW ADD



- 200 - 250 V

| Item No. | Size | EAN | Inner | Outer |
|----------|--------------------|-----------------|-------|-------|
| 741501 | 140 mm (5-1/2 in.) | 69426292 3791 4 | 10 | 120 |

SOLDERING IRON US PLUG



| Item No. | Size | EAN | Inner | Outer |
|----------|------|-----------------|-------|-------|
| 741562US | 25 W | 69426292 1802 9 | 10 | 30 |
| 741564US | 40 W | 1809 8 | 10 | 30 |
| 741565US | 60 W | 1811 1 | 10 | 30 |

AUTOMATIC WIRE STRIPPER

NEW ADD



- Strips 1.0, 1.6, 2.0, 2.6, 3.2 mm diameter cable
- Automatic clamping action and length gauge ensures stripped ends are uniform

| Item No. | Size | EAN | Inner | Outer |
|----------|------|-----------------|-------|-------|
| 741003 | | 69426292 6119 3 | 6 | 24 |

AUTOMATIC WIRE STRIPPER

NEW ADD



- Wire stripping: 0.2-6.0 mm² (#10-#24 AWG)
- Wire crimping: insulated & non-insulated terminals 0.5-6.0 mm² (#10-#22 AWG)
- Wire cutter

| Item No. | Size | EAN | Inner | Outer |
|----------|------|-----------------|-------|-------|
| 741004 | | 69426292 6120 9 | 6 | 24 |

TELESCOPING MAGNETIC PICKUP TOOL



- extends to 760 mm (30 in.)

| Item No. | Size | EAN | Inner | Outer |
|----------|----------------|-----------------|-------|-------|
| 739635 | 16 lb. (7.2kg) | 69426292 3936 9 | 6 | 24 |

14 IN 1 MULTI-FUNCTION PLIERS



- long nose pliers
- regular pliers
- wire cutter
- can opener
- bottle opener
- large knife
- fish scaler
- ruler
- file
- awl
- screwdriver PH
- screwdriver SL small
- screwdriver SL medium
- screwdriver SL large
- nylon pouch included

| Item No. | Size | EAN | Inner | Outer |
|----------|------|-----------------|-------|-------|
| 749018 | | 69426292 3930 7 | 6 | 36 |

BRASS PADLOCK



| Item No. | Size | EAN | Inner | Outer |
|----------|-------|-----------------|-------|-------|
| 752003 | 30 mm | 69426292 2723 6 | 6 | 120 |
| 752004 | 40 mm | 2729 8 | 6 | 96 |
| 752005 | 50 mm | 2731 1 | 6 | 60 |
| 752006 | 60 mm | 4984 9 | 6 | 48 |
| 752007 | 70 mm | 2732 8 | 6 | 36 |

SECURITY PADLOCK



| Item No. | Size | EAN | Inner | Outer |
|----------|-------|-----------------|-------|-------|
| 752057 | 70 mm | 69426292 2740 3 | 6 | 48 |
| 752058 | 80 mm | 2741 0 | 6 | 24 |

WIRE STRIPPER

NEW ADD



- Wire stripping: 0.2-6.0 mm² (#10-#24 AWG)

| Item No. | Size | EAN | Inner | Outer |
|----------|----------------|-----------------|-------|-------|
| 741021 | 130 mm (5 in.) | 69426292 3742 6 | 6 | 72 |

CRIMPING PLIERS

NEW ADD



- Crimping insulated terminals 22-18, 12-10, 22-10
- Cut bolts size: 6-32, 8-32, 10-32, 10-24, 4-40
- Wire stripping AWG #10-#22
- Wire cutting function

| Item No. | Size | EAN | Inner | Outer |
|----------|----------------|-----------------|-------|-------|
| 741031 | 200 mm (8 in.) | 69426292 6510 8 | 6 | 24 |

3 IN 1 CRIMPING TOOL

NEW ADD



- Crimps modular connectors in 8P-RJ45 and 6P-RJ11/12 formats
- Cuts and strips formal network and telephone cable

| Item No. | Size | EAN | Inner | Outer |
|----------|--------|-----------------|-------|-------|
| 741041 | 3 in 1 | 69426292 4004 4 | 6 | 24 |

PLASTIC TORCH 2D



- batteries not included

| Item No. | Size | EAN | Inner | Outer |
|----------|-------|-----------------|-------|-------|
| 753001 | 2 x D | 69426292 0935 5 | 6 | 36 |

PLASTIC TORCH 2AA



- batteries not included

| Item No. | Size | EAN | Inner | Outer |
|----------|--------|-----------------|-------|-------|
| 753013 | 2 x AA | 69426292 7072 0 | 12 | 48 |

2PC LADDER HOOK SET

NEW ADD



- 55 x 130 x 100 mm, 25 mm dia.

| Item No. | Size | EAN | Inner | Outer |
|----------|------|-----------------|-------|-------|
| 755502 | | 69426292 1942 2 | 12 | 72 |

250PC CABLE TIE SET

- 100pc 200 mm (8 in.) white
- 50pc 200 mm (8 in.) black
- 50pc 150 mm (6 in.) red
- 50pc 100 mm (4 in.) white

| Item No. | Size | EAN | Inner | Outer |
|----------|-------|----------|-------|-------|
| 780001 | 250pc | 69426292 | 0 | 15 |

22PC NYLON CLAMP SET

- 18pc 63 mm (2-1/2 in.)
- 4pc 90 mm (3-1/2 in.)

| Item No. | Size | EAN | Inner | Outer |
|----------|------|----------|-------|-------|
| 780002 | 22pc | 69426292 | 0 | 15 |

17PC SCREWDRIVER & BIT SET - SAE

- bit driver handle
- 10pc bits: SL-1/4, 3/16, 5/32 in.; PH-#1, #2, #3; T-10, T-15, T-20, T-25
- 6pc screwdriver: SL- 3 x 75 mm (1/8 x 3 in.) w/clip, 5 x 75 mm (3/16 x 3 in.), 6 x 100 mm (1/4 x 4 in.); PH- #0 x 75 mm (3 in.) w/clip, #1 x 75 mm (3 in.), #2 x 100 mm (4 in.)

| Item No. | Size | EAN | Inner | Outer |
|----------|------|----------|-------|-------|
| 780003 | 17pc | 69426292 | 0 | 15 |

6PC HOME TOOL SET

- 150 mm (6 in.) long nose pliers
- 150 mm (6 in.) adjustable wrench
- 3.5m (12 ft.) tape measure
- snap blade knife
- 2pc 100 mm (4 in.) screwdrivers

| Item No. | Size | EAN | Inner | Outer |
|----------|------|----------|-------|-------|
| 780004 | 6pc | 69426292 | 0 | 15 |

4PC PLIER SET

- 200 mm (8 in.) long nose pliers
- 175 mm (7 in.) linesman pliers
- 160 mm (6 in.) diagonal pliers
- 200 mm (8 in.) groove joint pliers

| Item No. | Size | EAN | Inner | Outer |
|----------|------|----------|-------|-------|
| 780009 | 4pc | 69426292 | 0 | 15 |



24PC T HANDLE SET

- 15pc 25 mm bits: SL- 3, 4, 5, 6 mm; PH- #0, #1, #2, #3; PZ- #1, #2; T-15, T-20, HEX- 4, 5, 6 mm
- 6pc 1/4 in. Dr. socket: 5, 6, 7, 8, 9, 10 mm
- 1pc 100 mm extension bar
- 1pc bit/socket adaptor
- 1pc mini ratchet T-handle

| Item No. | Size | EAN | Inner | Outer |
|----------|------|----------|-------|-------|
| 790136 | 24pc | 69426292 | 8 | 32 |

26PC PRECISION SET

- 24pc 28 mm precision bits: SL- 1.5, 2, 2.5, 3 mm x 3; PH- #000, #00, #0 x 3, #1; T-6, T-7, T-8, T-9, T-10, T-15, T-20; HEX- 1.5, 2.0, 2.5, 3.0, 4.0 mm
- 1pc 60 mm extension bar
- 1pc precision handle

| Item No. | Size | EAN | Inner | Outer |
|----------|------|----------|-------|-------|
| 790137 | 26pc | 69426292 | 8 | 32 |

27PC STUBBY SET

- 19pc 25 mm bits: SL- 4, 5, 6 mm; PH- #1, #2, #3; PZ- #1, #2, #3; T-10, T-15, T-20, T-25, T-30, T-40; HEX- 3, 4, 5, 6 mm
- 6pc 1/4 in. Dr. socket: 5, 6, 7, 8, 9, 10 mm
- 1pc bit/socket adaptor
- 1pc stubby ratchet handle

| Item No. | Size | EAN | Inner | Outer |
|----------|------|----------|-------|-------|
| 790138 | 27pc | 69426292 | 8 | 32 |

111PC TOOL SET

NEW ADD

- 200 mm box joint pliers
- 160 mm diagonal pliers
- 18 mm snap off knife
- 300 mm box level
- 200 mm half round file
- 110 mm magnetic bowl
- 300 g machinist hammer
- 3/8 in. Dr. quick release ratchet handle
- 16 pc 3/8 in. Dr. socket 6, 7, 8, 9, 10, 11, 12, 13, 14, 15, 16, 17, 18, 19, 21, 22mm
- 3/8 in. Dr. x 150 mm extension bar
- 3/8 in. (F) x 1/4 in. (M) adaptor
- 7 pc combination wrench 8, 10, 11, 12, 13, 14, 15 mm
- 4 pc screwdriver PH #1 x 75, #2 x 100, Slot 3.5 x 75, 6.5 x 100 mm
- 2 pc VDE screwdriver PH #1 x 80, Slot 2.5 x 75 mm
- screwdriver handle
- 30 pc bits
- precision screwdriver handle
- 20 pc precision bits
- 160 mm linesman pliers
- 150 mm adjustable wrench
- 5 pc 18mm blades
- 2 x AAA flashlight
- 5 m x 19 mm MID tape measure
- magnetic pick up tool
- 150 mm junior hacksaw
- 3/8 in. Dr. universal joint
- 7pc Cr-v hex key 1.5, 2, 2.5, 3, 4, 5, 6 mm

| Item No. | Size | EAN | Inner | Outer |
|----------|--------|----------|--------|-------|
| 780111 | 111 pc | 69426292 | 4022 8 | 6 12 |

129PC TOOL SET

- 6pc jewelers screwdriver: SL-1.4 mm (1/16 in.), 2 mm (5/64 in.), 2.4 mm (3/32 in.), 3 mm (1/8 in.), PH-#0, #00
- 22pc hex key: SAE- 1/4, 7/32, 3/16, 5/32, 9/64, 1/8, 7/64, 3/32, 5/64, 1/16, 3/64 in.; Metric- 6, 5.5, 5, 4.5, 4, 3.5, 3, 2.5, 2, 1.5, 1.27 mm
- ratchet handle: 3/8 in. DR. x 200 mm (8 in.)
- 2pc screwdriver: SL-1/4 in. x 160 mm (6 in.), PH-#2 x 160 mm (6 in.)
- 8pc combination wrench: SAE-9/16, 1/2, 7/16, 3/8 in.; Metric-10, 12, 13, 14 mm
- 24pc 1/4 in. DR. 6PT socket: SAE-1/2, 7/16, 15/32, 13/32, 3/8, 11/32, 5/16, 9/32, 1/4, 7/32, 3/16, 5/32 in.; Metric-4, 4.5, 5, 5.5, 6, 7, 8, 9, 10, 11, 12, 13 mm
- 11pc 3/8 in. DR. 6PT socket: SAE- 11/16, 5/8, 9/16, 1/2, 7/16 in.; Metric-10, 11, 12, 14, 17, 19 mm
- 3/8 in. DR. x 75 mm (3 in.) extension bar
- 3/8 in. (F) x 1/4 in. (M) adapt
- 3/8 in. DR. x 5/8 in. spark plug socket
- magnetic bit holder
- 160 mm (6 in.) long nose plier
- 160 mm (6 in.) diagonal plier
- 48pc bits set: SL- 1/8, 5/32, 3/16, 7/32, 1/4, 9/32 in.; PH- #0 x 2, #1 x 2, #3 x 2; PZ- #0 x 2, #1 x 2, #3 x 2; HEX- 3/32, 1/8, 5/32, 3/16, 7/32, 1/4 in.; T-10 x 2, T-15 x 2, T-20 x 2, T-10 x 2, T-15 x 2, T-20 x 2, T-25 x 2, T-27, T-30, T-35, T-40; S0, S1 x 2, S2 x 2, S3

| Item No. | Size | EAN | Inner | Outer |
|----------|-------|----------|--------|-------|
| 780031 | 129pc | 69426292 | 0248 6 | 0 4 |

116PC TOOL SET

- 44pc terminals
- electrician tape
- brass wire brush
- 9 mm utility knife
- magnetic bit holder
- 6-24 circuit tester
- 3pc screwdriver: SL- 1/4 x 4 in.; PH- #2 x 4 in., #1 x 3 in.
- 10pc combination wrench: SAE- 5/8, 9/16, 1/2, 7/16, 3/8 in.; Metric- 10, 12, 13, 14, 15 mm
- 16pc 3/8 in. DR. socket: SAE- 3/8, 7/16, 1/2, 9/16, 5/8, 11/16, 3/4 in.; Metric- 11, 12, 13, 14, 15, 16, 17, 18, 19 mm
- 8pc 1/4 in. DR. socket: SAE- 11/32, 5/16, 9/32, 1/4 in.; Metric- 7, 8, 9, 10 mm
- 200 mm (8 in.) crimping plier
- 115 mm (4-1/2 in.) diagonal plier
- 115 mm (4-1/2 in.) long nose plier
- 160 mm (6 in.) adjustable wrench
- 2pc spark plug socket 3/8 in. DR. x 5/8 in. 6 13/16 in.
- 3/8 in. DR. x 75 mm (3 in.) extension bar
- 3/8 in. DR. x 200 mm (8 in.) ratchet handle
- 3/8 in. (F) x 1/4 in. (M) adapt
- 3/8 in. DR. universal joint
- 20pc bit: SL- 3/16, 1/4, 5/16 in.; PH- #1, #2, #3; HEX- SAE- 1/8, 5/32, 3/16, 7/32 in.; Metric- 4 mm, 5 mm, 6 mm; T-10, T-15, T-20; S1, S2, S3; ADA

| Item No. | Size | EAN | Inner | Outer |
|----------|-------|----------|--------|-------|
| 780041 | 116pc | 69426292 | 3346 6 | 0 4 |

41PC TOOL BAG SET

- 5 pc screwdriver: SL-3 x 75 mm, 5 x 75 mm, 6 x 100 mm, PH-#1 x 75 mm, #2 x 100 mm
- 2 pc precision screwdriver: SL-2 mm, PH-#00
- 10 pc bits: SL- 5, 6 mm; PH- #1, #2, #3; T15, T20, HEX 4, 5, 6 mm
- 2 pc 63 mm mini nylon clamp
- 8 pc hex key: 1.5, 2, 2.5, 3, 4, 5, 5.5, 6 mm
- 160 mm adjustable wrench
- 3.5 m (12 ft.) tape measure
- 200 mm water pump pliers
- 160 mm long nose pliers
- 160 mm linesman pliers
- 160 mm diagonal pliers
- 160 mm torpedo level
- 18 mm snap off knife
- 225g claw hammer
- 250 mm hacksaw
- 100 mm bit driver
- 215 mm scissors
- 220V tester
- nylon bag

| Item No. | Size | EAN | Inner | Outer |
|----------|------|----------|--------|-------|
| 780032 | 41pc | 69426292 | 7783 5 | 0 8 |

41PC TOOL SET - METRIC

- magnetic bit holder
- 100pc hardware kit
- 18 mm snap-off knife
- 200 mm (8 in.) scissor
- tape measure 3.5 m (12 ft.)
- 160 mm (6 in.) long nose plier
- 60 mm (2-3/8 in.) magnet bar
- 160 mm (6 in.) adjustable wrench
- 8oz (225g) claw hammer-tubular
- 20pc bit: SL- 4, 5, 6 mm; PH- #1, #2, #3; PZ- #1, #2, #3; HEX- 3, 4, 5 mm; T-10, T-15, T-20, T-30; S1, S2, S3; ADA
- 4pc precision screwdriver: SL- 2.5, 3 mm; PH- #00, #0
- 8pc hex key: 1.5, 2, 2.5, 3, 4, 5, 5.5, 6 mm

| Item No. | Size | EAN | Inner | Outer |
|----------|------|----------|--------|-------|
| 780122 | 41pc | 69426292 | 4806 4 | 0 5 |

23PC TOOL BOX SET



- snap off knife
- 3.5 m (12 ft.) tape measure
- 225 mm (9 in.) torpedo level
- 225g (8 oz) tubular handle claw hammer
- 160 mm (6 in.) diagonal pliers
- 160 mm (6 in.) long nose pliers
- 8pc hex key: 1/16, 5/64, 3/32, 1/8, 5/32, 3/16, 7/32, 1/4 in.
- 30.5 cm (12 in.) plastic tool box
- 2pc screwdriver: SL- 6 mm (1/4 in.) & PH- #2 x 100 mm (4 in.)
- 1pc utility knife
- 160 mm (6 in.) linesman pliers
- 160 mm (6 in.) adjustable wrench
- 2pc screwdriver: SL- 6 mm (1/4 in.) x 100 mm (4 in.), PH- #2 x 100 mm (4 in.)

| Item No. | Size | EAN | Inner | Outer |
|----------|------|----------|-------|-------|
| 790041 | 23pc | 69426292 | 0 | 4 |

16PC TOOL SET



- 1pc hex key
- 1pc utility knife
- 160 mm (6 in.) linesman pliers
- 160 mm (6 in.) adjustable wrench
- 2pc screwdriver: SL- 6 mm (1/4 in.) x 100 mm (4 in.), PH- #2 x 100 mm (4 in.)

| Item No. | Size | EAN | Inner | Outer |
|----------|------|----------|-------|-------|
| 781016 | 16pc | 69426292 | 6 | 24 |

6PC WIRE BRUSH SET



- 2pc 40 mm wire wheel brush
- 1pc 50 mm wire wheel brush
- 1pc 60 mm wire wheel brush
- 1pc 75 mm wire wheel brush
- 1pc 50 mm wire cup brush

| Item No. | Size | EAN | Inner | Outer |
|----------|------|----------|-------|-------|
| 724211 | 6pc | 69743345 | 6 | 24 |

3PC SOCKET ADAPTOR SET



- 6.35 mm (1/4 in.) hex shank for using with quick chuck and extension

| Item No. | Size | EAN | Inner | Outer |
|----------|-------------------|--------|-------|-------|
| 742063 | 1/4, 3/8, 1/2 in. | 5860 2 | 10 | 60 |

10PC NUT DRIVER SET



- 746010: 4, 5, 6, 7, 8, 9, 10, 11, 12, 13 mm
- 746020: 5/32, 3/16, 7/32, 1/4, 9/32, 5/16, 11/32, 3/8, 7/16, 1/2 in.

| Item No. | Size | EAN | Inner | Outer |
|----------|--------|----------|-------|-------|
| 746010 | METRIC | 69426292 | 12 | 48 |
| 746020 | SAE | 4204 8 | 12 | 48 |

62PC INTERLOCK CASE SOCKET SET

NEW ADD



- 8 pc hex key 1.5, 2, 2.5, 3, 4, 5, 5.5, 6 mm
- 32 pc Cr-v bits
- 1 pc 1/4 in. Dr. x 70mm extension bar
- 1pc 1/4 in. (F) x 3/8 in. (M) adaptor
- 11 pc 1/4 in. Dr. sockets 4, 4.5, 5, 6, 7, 8, 9, 10, 11, 12, 13 mm
- 5 pc 3/8 in. Dr. sockets 14, 15, 16, 17, 19 mm
- 1pc 150 mm (6 in.) adjustable wrench
- 1 pc bits holder
- 1pc 1/4 in. Dr. ratchet handle
- 1 pc ratchet screwdriver
- Interlock case

| Item No. | Size | EAN | Inner | Outer |
|----------|-------|----------|-------|-------|
| 790201 | 62 pc | 69426292 | 6 | 12 |

43PC INTERLOCK CASE SOCKET SET

NEW ADD



- 1pc bits driver
- 10pc 1/4 in. Dr. sockets 4, 4.5, 5, 5.5, 6, 7, 8, 9, 10, 11 mm
- 1pc 3/8 in. (F) x 1/4 in. (M) adaptor
- 1 pc 3/8 in. Dr. x 70mm extension bar
- 1 pc 3/8 in. Dr. x 16 mm sparking plug socket
- 8 pc 3/8 in. Dr. sockets 12, 13, 14, 15, 17, 19, 21, 22 mm
- 1 pc 3/8 in. Dr. ratchet handle
- 20 pc Cr-v bits
- Interlock case

| Item No. | Size | EAN | Inner | Outer |
|----------|-------|----------|-------|-------|
| 790202 | 43 pc | 69426292 | 6 | 12 |

18PC COMBINATION DRILLS SET



- 3 x (3, 4, 5, 6, 8, 10 mm)

| Item No. | Size | EAN | Inner | Outer |
|----------|--------|--------|-------|-------|
| 742033 | METRIC | 5857 2 | 10 | 20 |

19PC HSS TWIST DRILLS SET

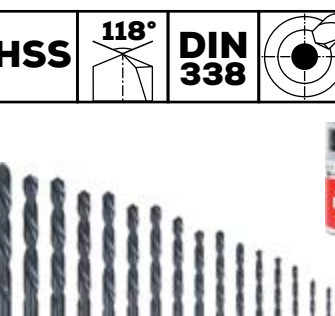

- 1, 1.5, 2, 2.5, 3, 3.5, 4, 4.5, 5, 5.5, 6, 6.5, 7, 7.5, 8, 8.5, 9, 9.5, 10 mm

| Item No. | Size | EAN | Inner | Outer |
|----------|--------|--------|-------|-------|
| 742035 | METRIC | 5858 9 | 10 | 20 |

19PC HSS TWIST DRILLS SET

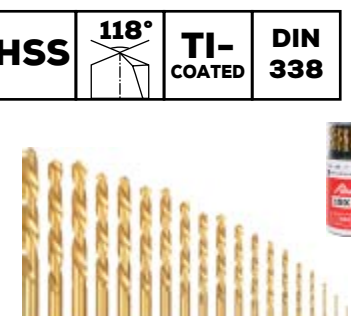

- 1, 1.5, 2, 2.5, 3, 3.5, 4, 4.5, 5, 5.5, 6, 6.5, 7, 7.5, 8, 8.5, 9, 9.5, 10 mm

| Item No. | Size | EAN | Inner | Outer |
|----------|--------|--------|-------|-------|
| 742037 | METRIC | 5859 6 | 10 | 20 |

26PC INTERLOCK CASE TOOL SET

NEW ADD



- 1 pc 225 g (8 oz) claw hammer
- 1 pc screwdriver bit holder
- 20 pc Cr-v bits
- 1 pc 150 mm (6 in.) adjustable wrench
- 1 pc 3.5 m (12 ft) x 12.5mm measuring tape
- 1 pc 160 mm (6 in.) linesman pliers
- 1 pc 9 mm snap off knife
- Interlock case

| Item No. | Size | EAN | Inner | Outer |
|----------|-------|----------|-------|-------|
| 790203 | 26 pc | 69426292 | 6 | 12 |

11PC INTERLOCK CASE SCREWDRIVER SET

NEW ADD



- 8 pc screwdrivers
- 3 pc precision screwdrivers
- Interlock case

| Item No. | Size | EAN | Inner | Outer |
|----------|-------|----------|-------|-------|
| 790204 | 11 pc | 69426292 | 6 | 12 |

SAE HSS DRILL BIT SET



- 742091: 1/16, 5/64, 3/32, 7/64, 1/8, 9/64, 5/32, 11/64, 3/16, 13/64, 7/32, 15/64, 1/4 in.
- 742095: 3/8, 23/64, 11/32, 21/64, 5/16, 19/64, 9/32, 17/64, 1/4, 15/64, 7/32, 13/64, 3/16, 11/64, 5/32, 9/64, 1/8, 7/64, 3/32, 5/64 & 1/16 in.

| Item No. | Size | EAN | Inner | Outer |
|----------|------|--------|-------|-------|
| 742091 | 13pc | 0945 4 | 12 | 48 |
| 742095 | 21pc | 0947 8 | 8 | 16 |

METRIC HSS DRILL BIT SET



- 742092: 1.5, 2, 2.5, 3, 3.2, 3.5, 4, 4.5, 4.8, 5, 5.5, 6, 6.5 mm
- 742096: 1, 1.5, 2, 2.5, 3, 3.5, 4, 4.5, 5, 5.5, 6, 6.5, 7, 7.5, 8, 8.5, 9, 9.5, 10 mm

| Item No. | Size | EAN | Inner | Outer |
|----------|------|--------|-------|-------|
| 742092 | 13pc | 4833 0 | 12 | 48 |
| 742096 | 19pc | 4834 7 | 8 | 16 |

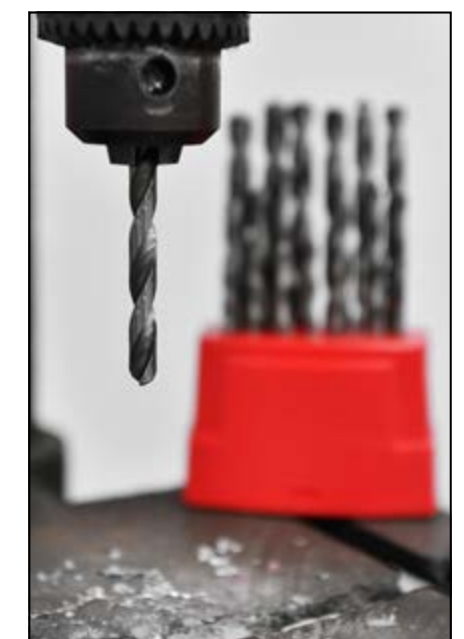

8PC MASONRY DRILL BIT SET

HM TCT **130°**

• 3, 4, 5, 6, 7, 8, 9, 10 mm

| Item No. | Size | EAN | Inner | Outer |
|----------|--------|----------|-------|-------|
| 742093 | METRIC | 69762270 | 12 | 72 |

5PC HOLE SAW SET

40mm (1-9/16in.) **65 MN**

• 28, 35, 50, 65, 75 mm

| Item No. | Size | EAN | Inner | Outer |
|----------|--------|----------|-------|-------|
| 742695 | METRIC | 69743345 | 6 | 36 |



SAFETY GOGGLES

| Item No. | Size | EAN | Inner | Outer |
|----------|------|----------|-------|-------|
| 750001 | | 69426292 | 12 | 48 |

SAFETY GLASSES

NEW ADD

• Polycarbonate lens provide excellent protection from impact
• Conforms to CE EN166

| Item No. | Size | EAN | Inner | Outer |
|----------|------|----------|-------|-------|
| 750051 | | 69762270 | 12 | 60 |

WELDING MASK

PP **108 x 50 mm** **DIN 10**

| Item No. | Size | EAN | Inner | Outer |
|----------|-------------|----------|-------|-------|
| 726901 | 108 x 50 mm | 69743345 | 0 | 10 |

54PC DRILL BIT SET-SAE

HSS **135°** **CRV**

• 60 mm (2-3/8 in.) magnetic bit extension
• 13pc drill set: 1/16, 5/64, 3/32, 5/32, 9/64, 1/8, 7/64, 1/4, 15/64, 7/32, 13/64, 3/16 & 11/64 in.
• 40pc 1 in. bit: SL-1/8, 5/32, 3/16 x 2, 7/32, 1/4 x 2, 9/32 in.; PH-#0 x 2, #1 x 2, #2 x 2, #3 x 2, PZ-#0, #1, #2 x 2, #3; HEX-1/16, 5/64, 3/32, 1/8, 5/32, 3/16, 7/64, 1/4 in.; T-8, T-10, T-15, T-20, T-25, T-27, T-30, T-40; S1, S2, S3

| Item No. | Size | EAN | Inner | Outer |
|----------|------|--------|-------|-------|
| 742853 | SAE | 0949 2 | 6 | 36 |

54PC DRILL BIT SET-METRIC

HSS **118°** **CRV**

• 60 mm (2-3/8 in.) magnetic bit extension
• 13pc drill set: 1.5, 2, 2.5, 3, 3.2, 3.5, 4, 4.5, 4.8, 5, 5.5, 6, 6.5 mm
• 40pc 1 in. bit: SL- 3, 4, 5, 5.5, 6, 6, 7 mm; PH- #0 x 2, #1 x 2, #2 x 2, #3 x 2; PZ- #0, #1, #2, #3; HEX- H1.5, H2, H2, H3, H4, H5, H5.5, H6; T-8, T-10, T-15, T-20, T-25, T-27, T-30, T-40; S1, S2, S3.

| Item No. | Size | EAN | Inner | Outer |
|----------|--------|--------|-------|-------|
| 742854 | METRIC | 4835 4 | 6 | 36 |

CUT OFF WHEELS - INOX

NEW ADD

TYPE 41
EN 12413
80 M/S

| Item No. | Size | EAN | Inner | Outer |
|----------|----------------------------------|-------|-------|-------|
| 744136 | 115x1x22mm (4-1/2x1/25x7/8in.) | 32077 | 50 | 400 |
| 744137 | 115x1.6x22mm (4-1/2x1/16x7/8in.) | 32084 | 50 | 400 |
| 744138 | 115x3.2x22mm (4-1/2x1/8x7/8in.) | 38048 | 20 | 200 |
| 744151 | 180x1.6x22mm (7x1/16x7/8in.) | 32091 | 20 | 200 |
| 744153 | 180x3.2x22mm (7x1/8x7/8in.) | 38055 | 25 | 100 |
| 744162 | 230x1.6x22mm (9x1/16x7/8in.) | 32107 | 50 | 100 |
| 744170 | 355x3.2x25.4mm (14x1/8x1in.) | 32114 | 0 | 25 |

2PC KNEE PAD

CE
EN 14404:2004 *A1:2010

| Item No. | Size | EAN | Inner | Outer |
|----------|------|--------|-------|-------|
| 750202 | | 5854 1 | 6 | 24 |

EAR MUFF

NEW ADD

• EN352-1
• 24dB

| Item No. | Size | EAN | Inner | Outer |
|----------|------|--------|-------|-------|
| 750301 | | 3765 2 | 6 | 12 |

SAFETY HELMET - HDPE

NEW ADD

• CE EN397
• HDPE material

| Item No. | Size | EAN | Inner | Outer |
|----------|------|--------|-------|-------|
| 750101 | | 3764 5 | 0 | 20 |

HSS DRILL BITS METAL CASE SET

HSS **4241**

• 7/64, 5/64, 1/16, 3/32, 1/8, 9/64, 5/32, 11/64, 3/16, 13/64, 7/32, 15/64, 1/4, 17/64, 9/32, 19/64, 5/16, 21/64, 11/32, 23/64, 3/8, 25/64, 13/32, 27/64, 7/16, 29/64, 15/32, 31/64 & 1/2 in.

| Item No. | Size | EAN | Inner | Outer |
|----------|------|--------|-------|-------|
| 742097 | 29pc | 0948 5 | 0 | 10 |

HSS DRILL BITS METAL CASE SET

HSS **4241**

• 1, 1.5, 2, 2.5, 3, 3.5, 4, 4.5, 5, 5.5, 6, 6.5, 7, 7.5, 8, 8.5, 9, 9.5, 10, 10.5, 11, 11.5, 12, 12.5, 13 mm

| Item No. | Size | EAN | Inner | Outer |
|----------|------|--------|-------|-------|
| 742098 | 25pc | 3232 9 | 0 | 10 |

GRINDING WHEELS - INOX

NEW ADD

TYPE 27
EN 12413
80 M/S

| Item No. | Size | EAN | Inner | Outer |
|----------|---------------------------------|-------|-------|-------|
| 744183 | 115x6.4x22mm (4-1/2x1/4x7/8in.) | 32121 | 25 | 100 |
| 744190 | 180x6.4x22mm (7x1/4x7/8in.) | 38062 | 25 | 50 |



5PC DUST MASKS

| Item No. | Size | EAN | Inner | Outer |
|----------|------|--------|-------|-------|
| 750605 | | 1404 5 | 6 | 48 |

NITRILE COATED GLOVES

#10 **XL** **CE** **EN388** **411X**

| Item No. | Size | EAN | Inner | Outer |
|----------|------|--------|-------|-------|
| 751001 | SAE | 0945 4 | 12 | 48 |

INSTRUCTION MANUAL FOR QP #5



INSTRUCTION MANUAL FOR QP #3



| Item No. | QP height | QP QTY/pallet | Pallet height | EU Pallet QTY | | US Pallet QTY | | AU Pallet QTY | |
|----------|-----------|---------------|---------------|---------------|--------|---------------|--------|---------------|--------|
| | (cm) | | | 20 ft. | 40 ft. | 20 ft. | 40 ft. | 20 ft. | 40 ft. |
| QP #3 | 78 | 4 | 91 | 88 | 192 | 72 | 168 | 80 | 160 |
| QP #5 | 100 | 4 | 113 | 88 | 192 | 72 | 168 | 80 | 160 |

| | | | | | | | | | | | | | | | | | | | | | | | |
|--------|---|-----|--------|----|-----|--------|----|-----|--------|----|-----|--------|----|-----|--------|----|-----|--------|----|-----|----------|----|-----|
| 700001 | 1 | New | 702137 | 6 | | 704005 | 11 | | 706508 | 14 | | 712735 | 20 | | 730106 | 26 | new | 735203 | 28 | | 741031 | 31 | new |
| 700003 | 1 | | 702141 | 6 | | 704007 | 11 | | 706792 | 14 | | 712743 | 20 | | 730121 | 26 | new | 735205 | 28 | | 741041 | 31 | new |
| 700005 | 1 | | 702143 | 6 | | 704009 | 11 | | 706803 | 15 | | 712752 | 20 | | 730123 | 26 | new | 735213 | 28 | | 741051 | 32 | new |
| 700006 | 1 | | 702145 | 6 | | 704011 | 11 | | 706811 | 15 | | 712781 | 20 | | 733001 | 26 | new | 735215 | 28 | | 741501 | 32 | new |
| 700007 | 1 | | 702201 | 7 | | 704013 | 11 | | 706813 | 15 | | 713101 | 21 | | 733004 | 26 | new | 735220 | 28 | new | 741562US | 32 | |
| 700008 | 1 | | 702203 | 7 | | 704015 | 11 | | 706815 | 15 | | 713103 | 21 | | 733051 | 26 | new | 735222 | 28 | | 741564US | 32 | |
| 700009 | 1 | | 702204 | 7 | | 704023 | 11 | | 706821 | 15 | | 713105 | 21 | | 733054 | 26 | new | 735408 | 29 | new | 741565US | 32 | |
| 700011 | 1 | | 702205 | 7 | | 704031 | 11 | | 706823 | 15 | | 713151 | 21 | | 733101 | 26 | new | 735409 | 29 | new | 742033 | 36 | |
| 700016 | 1 | | 702207 | 7 | | 704032 | 11 | | 706825 | 15 | | 713153 | 21 | | 733104 | 26 | new | 735410 | 29 | new | 742035 | 36 | |
| 700027 | 1 | | 702209 | 7 | | 704033 | 11 | | 706937 | 15 | new | 713155 | 21 | | 734011 | 26 | | 735411 | 29 | new | 742037 | 36 | |
| 700031 | 1 | | 702211 | 7 | | 704034 | 11 | | 707003 | 15 | | 713311 | 21 | | 734013 | 26 | | 735412 | 29 | new | 742063 | 36 | |
| 700033 | 1 | | 702213 | 7 | | 705001 | 11 | | 707006 | 15 | | 713315 | 21 | | 734021 | 27 | | 735413 | 29 | new | 742091 | 36 | |
| 700041 | 1 | | 702231 | 7 | | 705002 | 11 | | 708001 | 15 | | 713317 | 21 | | 734111 | 26 | | 735414 | 29 | new | 742092 | 36 | |
| 700043 | 1 | | 702233 | 7 | | 705003 | 11 | | 708003 | 15 | | 713319 | 21 | | 734113 | 26 | | 735415 | 29 | new | 742093 | 37 | |
| 700045 | 1 | | 702235 | 7 | | 705004 | 11 | | 708013 | 16 | | 713321 | 21 | | 734121 | 27 | | 735416 | 29 | new | 742095 | 36 | |
| 700048 | 2 | | 702237 | 7 | | 705005 | 11 | | 708031 | 16 | | 713323 | 21 | | 734211 | 26 | | 735417 | 29 | new | 742096 | 36 | |
| 700061 | 2 | | 702239 | 7 | | 705006 | 11 | | 709003 | 16 | | 714001 | 21 | | 734213 | 26 | | 735418 | 29 | new | 742097 | 37 | |
| 700063 | 2 | | 702241 | 7 | | 705008 | 11 | | 709005 | 16 | | 714012 | 21 | | 734221 | 27 | | 735419 | 29 | new | 742098 | 37 | |
| 700065 | 2 | | 702243 | 7 | | 705013 | 11 | | 709007 | 16 | | 714052 | 22 | new | 734421 | 27 | | 735453 | 29 | new | 742695 | 37 | |
| 700067 | 2 | | 702245 | 7 | | 705024 | 11 | | 709014 | 16 | | 714054 | 22 | new | 734440 | 27 | | 735454 | 29 | new | 742853 | 37 | |
| 700069 | 2 | | 702261 | 7 | | 705032 | 11 | | 709015 | 16 | | 714083 | 22 | | 734452 | 27 | | 735455 | 29 | new | 742854 | 37 | |
| 700083 | 2 | | 702263 | 7 | | 705036 | 11 | | 709031 | 16 | | 714112 | 22 | new | 734453 | 27 | | 735456 | 29 | new | 744136 | 37 | new |
| 700085 | 2 | | 702265 | 7 | | 705162 | 11 | | 709032 | 16 | | 714116 | 22 | new | 734515 | 27 | | 735457 | 29 | new | 744137 | 37 | new |
| 700101 | 3 | | 702267 | 7 | | 705184 | 12 | | 709033 | 16 | | 715701 | 22 | new | 734521 | 27 | | 735458 | 29 | new | 744138 | 37 | new |
| 700103 | 3 | | 702269 | 7 | | 705204 | 12 | | 709203 | 16 | | 715702 | 22 | new | 734603 | 28 | new | 735459 | 29 | new | 744151 | 37 | new |
| 700105 | 3 | | 702270 | 7 | new | 705206 | 12 | | 709205 | 16 | | 718301 | 22 | new | 735006 | 28 | new | 735460 | 29 | new | 744153 | 37 | new |
| 700106 | 3 | | 702271 | 7 | | 705325 | 12 | | 709207 | 16 | | 718303 | 22 | new | 735007 | 28 | new | 735608 | 29 | new | 744162 | 37 | new |
| 700107 | 3 | | 702273 | 7 | | 705330 | 12 | | 709380 | 16 | | 718305 | 22 | new | 735008 | 28 | | 735609 | 29 | new | 744170 | 37 | new |
| 700108 | 3 | | 702275 | 7 | | 705601 | 12 | | 709383 | 16 | | 718405 | 23 | | 735009 | 28 | | 735610 | 29 | new | 744183 | 37 | new |
| 700109 | 3 | | 702277 | 7 | | 705603 | 12 | new | 709404 | 17 | | 718801 | 23 | | 735010 | 28 | | 735611 | 29 | new | 744190 | 37 | new |
| 700111 | 3 | | 702279 | 7 | | 706001 | 12 | | 709411 | 17 | | 718802 | 23 | new | 735011 | 28 | | 735612 | 29 | new | 746010 | 36 | |
| 700131 | 3 | | 702281 | 7 | | 706002 | 12 | | 709423 | 17 | | 718821 | 23 | new | 735012 | 28 | | 735613 | 29 | new | 746020 | 36 | |
| 700133 | 3 | | 702283 | 7 | new | 706003 | 12 | | 709511 | 17 | new | 718823 | 23 | new | 735013 | 28 | | 735614 | 29 | new | 749018 | 32 | |
| 700141 | 3 | | 702284 | 7 | new | 706004 | 12 | | 709515 | 17 | new | 719001 | 23 | | 735014 | 28 | | 735615 | 29 | new | 750001 | 38 | |
| 700143 | 3 | | 702312 | 7 | | 706005 | 12 | | 709520 | 17 | new | 720103 | 23 | | 735015 | 28 | | 735616 | 29 | new | 750051 | 38 | new |
| 700145 | 3 | | 702313 | 7 | | 706012 | 12 | new | 710002 | 17 | new | 720106 | 23 | | 735016 | 28 | | 735617 | 29 | new | 750101 | 38 | new |
| 700161 | 3 | | 702314 | 7 | | 706013 | 12 | new | 710003 | 17 | | 720206 | 23 | | 735017 | 28 | | 735618 | 29 | new | 750202 | 38 | |
| 700163 | 3 | | 702407 | 6 | | 706014 | 12 | new | 710004 | 17 | new | 721001 | 24 | | 735018 | 28 | | 735619 | 29 | new | 750301 | 38 | new |
| 700165 | 4 | | 702415 | 8 | | 706015 | 12 | new | 710005 | 17 | new | 721003 | 24 | | 735019 | 28 | | 735622 | 29 | new | 750605 | 38 | |
| 700167 | 4 | | 702416 | 8 | | 706016 | 12 | new | 710012 | 17 | | 721005 | 24 | | 735020 | 28 | | 735801 | 29 | new | 751001 | 38 | |
| 700181 | 4 | | 702428 | 6 | | 706018 | 12 | new | 710023 | 17 | | 721007 | 24 | | 735021 | 28 | | 735802 | 29 | new | 752003 | 32 | |
| 700183 | 4 | | 702432 | 6 | | 706020 | 12 | new | 710031 | 18 | | 721051 | 24 | | 735022 | 28 | | 735803 | 29 | new | 752004 | 32 | |
| 700186 | 4 | | 702461 | 8 | | 706103 | 13 | | 710033 | 18 | | 721053 | 24 | | 735023 | 28 | new | 735804 | 29 | new | 752005 | 32 | |
| 700194 | 4 | | 702476 | 8 | | 706112 | 13 | new | 710035 | 18 | | 721302 | 24 | | 735024 | 28 | | 735805 | 29 | new | 752006 | 32 | |
| 700210 | 4 | | 702478 | 8 | | 706113 | 13 | | 710041 | 17 | | 721304 | 24 | | 735025 | 28 | new | 735806 | 29 | new | 752007 | 32 | |
| 700306 | 4 | | 702479 | 8 | | 706114 | 13 | new | 710042 | 17 | | 721306 | 24 | | 735026 | 28 | new | 735807 | 29 | new | 752057 | 32 | |
| 700501 | 5 | | 702483 | 9 | | 706117 | 13 | | 710043 | 17 | | 721323 | 24 | | 735027 | 28 | | 735808 | 29 | new | 752058 | 32 | |
| 700503 | 5 | | 702484 | 8 | | 706118 | 13 | | 710044 | 17 | | 721331 | 24 | new | 735028 | 28 | | 735809 | 29 | new | 753001 | 32 | |
| 700505 | 5 | | 702488 | 9 | | 706161 | 13 | new | 710047 | 17 | | 721332 | 24 | new | 735029 | 28 | | 735810 | 29 | new | 753013 | 32 | |
| 700507 | 5 | | 702489 | 9 | | 706162 | 13 | new | 710051 | 18 | | 721333 | 24 | new | 735030 | 28 | | 735811 | 29 | new | 755502 | 32 | new |
| 700509 | 5 | | 702490 | 8 | new | 706163 | 13 | | 710054 | 18 | | 721334 | 24 | new | 735032 | 28 | | 735812 | 29 | new | 780001 | 33 | |
| 700512 | 6 | | 702509 | 7 | | 706164 | 13 | | 710055 | 18 | | 721343 | 24 | | 735105 | 28 | | 735827 | 29 | new | 780002 | 33 | |
| 700513 | 6 | | 702513 | 7 | | 706165 | 13 | | 710702 | 18 | new | 721351 | 24 | new | 735106 | 28 | | 737111 | 29 | | 780003 | 33 | |
| 700525 | 5 | | 702618 | 9 | | 706166 | 13 | new | 711001 | 18 | | 721353 | 24 | new | 735107 | 28 | | 737123 | 29 | | 780004 | 33 | |
| 700912 | 5 | new | 702620 | 9 | | 706203 | 14 | | 711003 | 18 | | 724003 | 24 | | 735108 | 28 | | 737131 | 29 | | 780009 | 33 | |
| 701024 | 5 | | 702625 | 9 | | 706223 | 13 | | 711006 | 18 | | 724013 | 25 | | 735109 | 28 | | 737133 | 29 | | 780031 | 34 | |
| 701026 | 5 | | 702628 | 9 | | 706225 | 13 | new | 711009 | 18 | | 724051 | 25 | | 735110 | 28 | | 737318 | 30 | | 780032 | 34 | |
| 701027 | 5 | | 702631 | 10 | | 706226 | 13 | new | 711075 | 19 | | 724052 | 25 | | 735111 | 28 | | 737331 | 30 | new | 780041 | 34 | |
| 701028 | 5 | new | 702633 | 10 | | 706227 | 13 | | 711102 | 19 | | 724053 | 25 | | 735112 | 28 | | 737332 | 30 | new | 780111 | 34 | new |
| 701029 | 5 | new | 702635 | 10 | | 706228 | 13 | | 711151 | 19 | | 724054 | 25 | | 735113 | 28 | | 737333 | 30 | new | 780122 | 34 | |
| 702101 | 6 | | 702636 | 10 | | 706243 | 14 | | 711153 | 19 | | 724055 | 25 | | 735114 | 28 | | 737352 | 30 | new | 781016 | 35 | |
| 702102 | 6 | | 702681 | 10 | new | 706253 | 14 | | 711161 | 19 | new | 724104 | 25 | | 735115 | 28 | | 739110 | 30 | | 790041 | 35 | |
| 702105 | 6 | | 702682 | 10 | new | 706302 | 14 | new | 711185 | | | | | | | | | | | | | | |



CATALOGUE 2025

www.onsitertools.com



MERIDIAN
美瑞实业

Meridian International Co., Ltd.

1886 Laiyin Road, Songjiang, Shanghai, China

Tel: (021) 3763 3311

Fax: (021) 3763 3322

www.meridianintl.com

Distributed by

